

USER MANUAL

4 CHANNELS

NETWORK VIDEO RECORDER



INSTRUCTION MANUAL

To obtain the best performance and ensure device function correctly, please read this instruction manual carefully and completely.

FCC Compliance

USER-INSTALLER CAUTION: YOUR AUTHORITY TO OPERATE THIS FCC VERIFIED EQUIPMENT COULD BE VOIDED IF YOU MAKE CHANGES OR MODIFICATIONS NOT EXPRESSLY APPROVED BY THE PARTY RESPONSIBLE FOR COMPLIANCE TO PART 15 OF THE FCC RULES.

NOTE: THIS EQUIPMENT HAS BEEN TESTED AND FOUND TO COMPLY WITH THE LIMITS FOR A CLASS A DIGITAL DEVICE, PURSUANT TO PART 15 OF THE FCC RULES. THESE LIMITS ARE DESIGNED TO PROVIDE REASONABLE PROTECTION AGAINST HARMFUL INTERFERENCE WHEN THE EQUIPMENT IS OPERATED IN A COMMERCIAL ENVIRONMENT. THIS EQUIPMENT GENERATES, USES, AND CAN RADIATE RADIO FREQUENCY ENERGY AND IF NOT INSTALLED AND USED IN ACCORDANCE WITH THE INSTRUCTION MANUAL, MAY CAUSE HARMFUL INTERFERENCE TO RADIO COMMUNICATIONS.

OPERATION OF THIS EQUIPMENT IN A RESIDENTIAL AREA IS LIKELY TO CAUSE HARMFUL INTERFERENCE IN WHICH CASE THE USER WILL BE REQUIRED TO CORRECT THE INTERFERENCE AT HIS OWN EXPENSE.



THIS CLASS A DIGITAL APPARATUS MEETS ALL REQUIREMENTS OF THE CANADIAN INTERFERENCE-CAUSING EQUIPMENT REGULATIONS.

WARNINGS, CAUTIONS & COPYRIGHT



WARNING

TO REDUCE THE RISK OF FIRE OR ELECTRIC SHOCK, DO NOT EXPOSE THIS PRODUCT TO RAIN OR MISTURE.
DO NOT INSERT ANY METALLIC OBJECT THROUGH VENTILATION GRILLS.

CAUTION

	CAUTION RISK OF ELECTRIC SHOCK DO NOT OPEN	
<p>CAUTION: TO REDUCE THE RISK OF ELECTRIC SHOCK. DO NOT REMOVE COVER (OR BACK). NO USER-SERVICEABLE PARTS INSIDE. REFER SERVICING TO QUALIFIED SERVICE PERSONNEL.</p>		

Explanation of Graphical Symbols

	The lightning flash with arrowhead symbol, within an equilateral triangle, is intended to alert the user to the presence of insinuated "dangerous voltage" within the products enclosure that may be of sufficient magnitude to constitute a risk of electric shock to persons.
	The exclamation point within an equilateral rhombus is intended to alert the user to the presence of important operating and maintenance (servicing) instruction in the literature accompanying the product.

USERS OF THE SYSTEM ARE RESPONSIBLE FOR CHECKING AND COMPLYING WITH ALL FEDERAL, STATE, AND LOCAL LAWS AND STATUTES COIPCERNING THE MONITORING AND RECORDING OF VIDEO AND AUDIO SIGNALS. ULTRAK SHALL NOT BE HELD RESPONSIBLE FOR THE USE OF THIS SYSTEM IN VIOLATION OF CURRENT LAWS AND STATUTES.

COPYRIGHT

THE TRADEMARKS MENTIONED IN THE MANUAL ARE LEGALLY REGISTERED TO THEIR RESPECTIVE COMPANIES.

TABLE OF CONTENTS

1	INTRODUCTION	4
1.1	FEATURES	4
1.2	SPECIFICATIONS	4
2	HARDWARE OVERVIEW	7
2.1	FRONT PANEL	7
2.2	BACK PANEL	8
2.3	ALARM TRIGGER	8
2.4	NETWORK ENVIRONMENT RECOMMENDATION	10
3	SYSTEM SETUP	10
3.1	MENU SETUP INTERFACE(GUI)	10
3.2	LIVE VIEWING AND POP-UP MENU	12
3.3	CAMERA SETUP	17
3.4	RECORD SETUP	28
3.5	ALARM SETUP	31
3.6	NETWORK SETUP	35
3.7	AUTHORITY SETUP	44
3.8	DISK MANAGEMENT	47
3.9	SYSTEM SETUP	49
4	NVR PLAYBACK	55
4.1	TIME SEARCH	57
4.2	EVENT SEARCH	57
4.3	BACKUP	58
4.4	SYSTEM LOG	59
5	BACKUP PLAYBACK	60
5.1	MAIN SCREEN SETTING	61
5.2	PLAYBACK OPERATION	65
6	NETWORK VIEWING & PLAYBACK	68
6.1	IP ADDRESS SETUP ON PC SITE	69
6.2	OPTIONAL MICROSOFT INTERNET EXPLORER SETUP	70
6.3	LOGIN	71
6.4	REMOTE CONTROL	73
6.5	CONFIGURATION	77
	APPENDIX A: RECORDING TIME LAPSE (HOURS)	92
	APPENDIX C: ERROR MESSAGE LIST	96

1 INTRODUCTION

1.1 FEATURES

- Support 4-channel IP cameras input.
- Support H.264 / MPEG4 decoding.
- Real-time Display & Playback.
- Support 5 Megapixel IP Camera for each channel.
- Support HDDs x2
- Support HDMI Video interface.
- Support CMS (Central Management System) control
- Audio Backup for all channels
- Graphic User Interface (GUI).
- Support time-point backup function under Ethernet remote control mode. User can select any time period to process backup from remote side.
- Support time-search & event-search function under Ethernet remote control mode.
- Up to four online clients for independent remote control; individual live-time, play-back & time-search function available
- Support PPPoE/ Static/ DHCP IP & DDNS.
- Powerful mobile surveillance function, support i-Phone & Android

1.2 SPECIFICATIONS

MODEL		HNR-04EC
System		
OS		Embedded Linux
Connector	Ethernet	RJ-45, 10/100/1000 Mbps x1
	Video output	VGA x1 / HDMI x1
	USB	Front : USB 2.0 x2
Power		DC-12V, 4.16A
Video and Audio		
Video input		4 channels
Audio input		4 channels

NVR Functions	
Camera Name	Max. 20 characters
Screen Split Control	1, 4
Image Control	12 Contrast / Brightness / Saturation / Hue
Recording mode	13 Manual / Schedule / Alarm
Pre Recording	14 5~30 sec
Searching and Playback	
Search Method	Date / Time / Event
Date/ Time / Event Search	Selectable on the calendar
Log Search	Through the log data to find the video event / time
Backup Type	USB
Remote Client Software	
Monitoring Environment	Hunt CMS, Iprosecu M.V2 for I phone / I pad , Iprosecu A.M.V2 for Android phone / Android pad, Web site
IP cam Live View	4 Channels
Remote Search	Web site remote time / event search
System Monitoring and Recovery	
Monitoring	Watchdog
Peripheral Devices	
Audio in	3.5 Ø Earphone stereo jack
Audio out	3.5 Ø Earphone stereo jack
STORAGE & BACKUP DEVICE	
INTERNAL HDD SUPPORT	SATA HDD x 2
EXTERNAL USB BACKUP DEVICE	USB x2
RAID	N/A
Networking	
Type	Static/ DHCP/ PPPoE/DDNS
Environment	
Operating Temp.	0 - 45 °C / 32~113 F
Humidity	0~80% RH (non-condensing)
Language	
Type	English / Traditional Chinese / Simple Chinese / Russian / Italian / Japanese / Czech / France / Germany / Spanish / Portuguese

Physical	
Color	Black
Dimensions (W x H x D)	115 x 175 x 144.5 mm
Weight	1.6 KG



* SPECIFICATIONS ARE SUBJECT TO CHANGE WITHOUT NOTICE

2 HARDWARE OVERVIEW

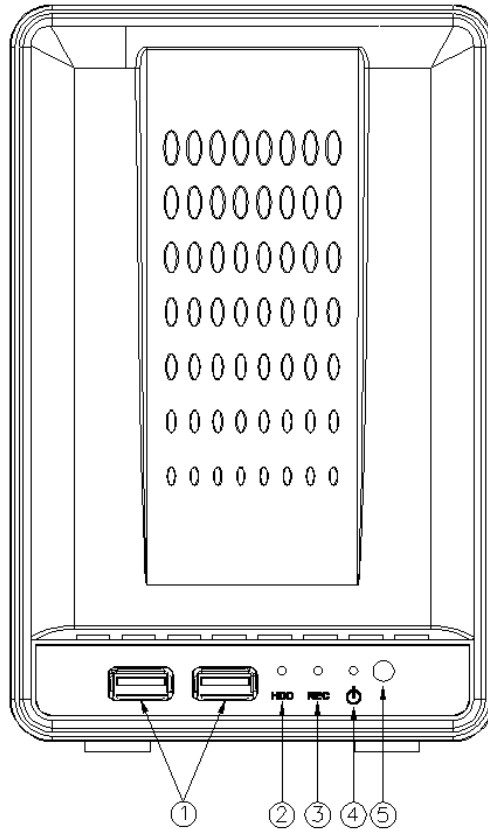
2.1 FRONT PANEL



NVR OPERATION

NO.	LABEL	OPERATION
1	 / 	USB connector/ USB mouse connector.
2	LED	HDD, record, power LED indicator.
3		
4		
5		IR sensor.

2.2 BACK PANEL

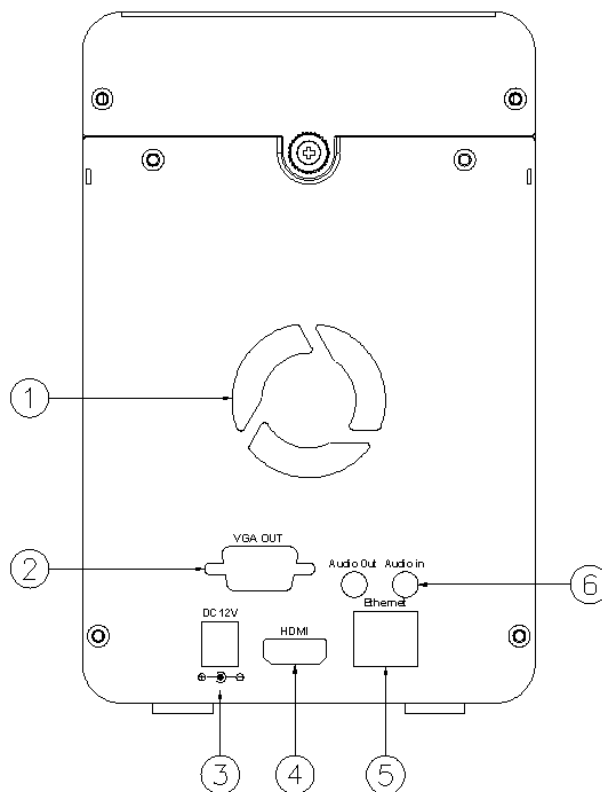

NO.	LABEL	OPERATION
1	FAN	Fan louvers
2	VIDEO OUT (VGA)	Connect to LCD monitor
3	POWER	Connect to power adapter (AC 12V/5A)
4	VIDEO OUT (HDMI)	HDMI video output
5	AUDIO IN/ AUDIO OUT	Microphone input(Phone Jack) Earphone output(Phone Jack)
6	ETHERNET	RJ-45 connector.

2.3 ALARM TRIGGER

There are four types of alarms: Motion detection, Video Loss Alarm, External Alarm, and Digital Input from Camera. The following are the possible actions when the alarm is triggered. Every action is configurable (Ex. the screen display pattern, the relay triggered time.etc) and will be explained in the later chapter.

A. When Motion detection occurs:

- a. The live screen pattern can be switch to single channel screen or split screen.
- b. The external relay/ built-in buzzer can be triggered.
- c. The alarm timepoint can be recorded in the event list, and you can search for the event in playback.
- d. On the channel which the alarm is triggered, the icon  pops up to remind the user.
- e. The pre/ post-alarm recording video can be sent to e-mail/ uploaded to FTP.
- f. The CGI can be sent to an http server.

B. When External Alarm or Digital Input from Camera happen:

- a. The external relay/ built-in buzzer can be triggered.
- b. The alarm timepoint can be recorded in the event list, and you can search for the event in playback.
- c. On the channel which the alarm is triggered, the icon  pops up to remind the user.
- d. The pre/ post-alarm recording video can be sent to e-mail/ uploaded to FTP.
- e. The CGI can be sent to an http server.

C. When Video Loss Alarm occurs:

- a. The external relay/ built-in buzzer can be triggered.
- b. Alarm timepoint can be recorded in the event list, and you can search for the event in playback.
- c. On the channel which the alarm is triggered, the icon  pops up to remind the user.
- d. The CGI can be sent to an http server.

2.4 NETWORK ENVIRONMENT RECOMMENDATION

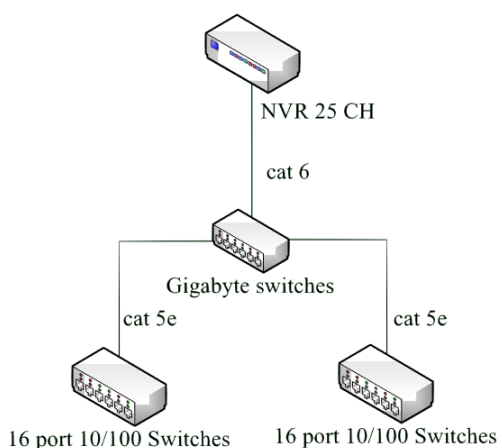

When setting up 4Mbps per channel, it's not recommended to connect more than 25 IP cameras under a 10/100 switch. It is suggested to connect 1~16 IP cams on each 10/100 switch when you setting up 4Mbps per channel.

Make sure of using Cat.6 Ethernet cable when connecting a Giga switch.

3 SYSTEM SETUP

3.1 MENU SETUP INTERFACE(GUI)



A.  CAMERA SETUP



B.  RECORD SETUP





C. ALARM SETUP



D. NETWORK SETUP

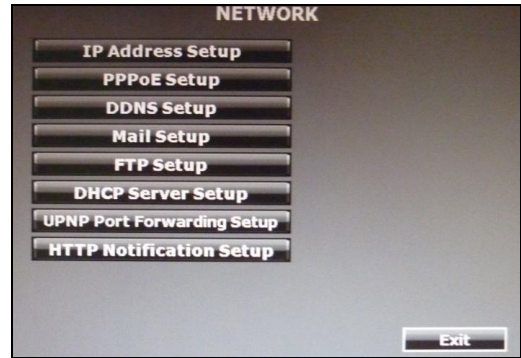

E. AUTHORITY SETUP

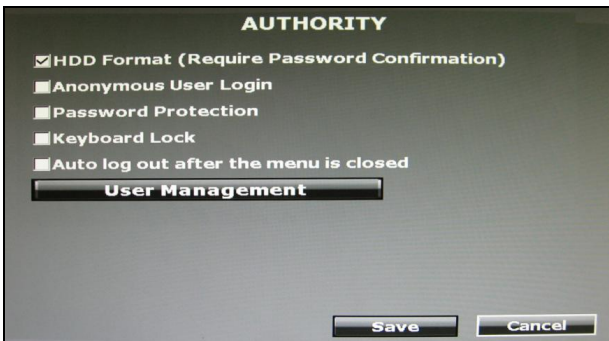

F. DISK MANAGEMENT



G. SYSTEM SETUP

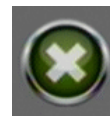

H. EXIT

3.2 LIVE VIEWING AND POP-UP MENU



NOTE : *The pop-up menu can be activated by moving the mouse cursor to the bottom of the live viewing screen.

A. PLUG & PLAY

When turning on the machine by the first time or when one of the IP address are set **ENABLE:OFF**, the system will ask you for assigning an IP address to the IP Cam for getting automatic connection.

The system will check addresses from 192.168.X.0, with X being the NVR LAN.

Once the user executes the function, the IP address of the IP Cam will be changed if the IP Cam and NVR are under different LAN. The IP address will be assigned from 192.168.X.50

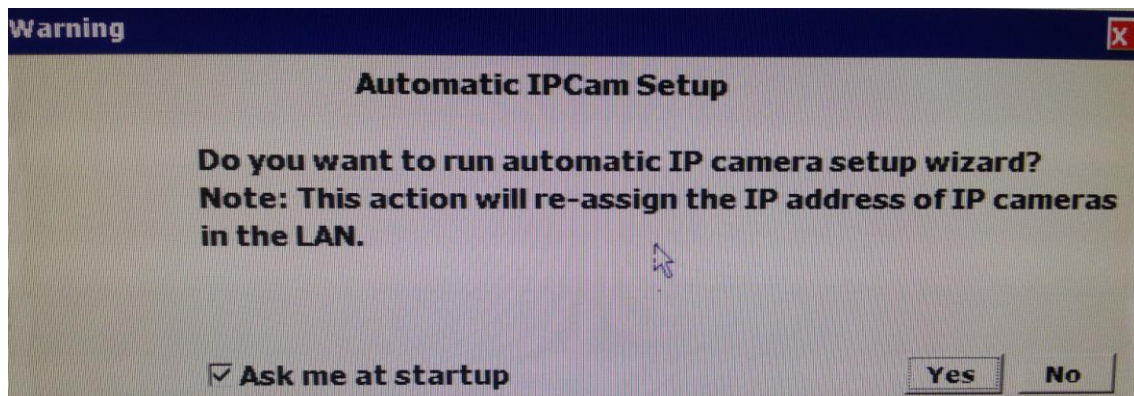



B. GUI MENU BAR

On live viewing mode, press this button to get into the GUI menu.



C. DISK INFORMATION

On live viewing mode press this button to display disk information.



D. DIGITAL ZOOM

In the live full screen mode, left-click the button of the mouse to pull a range to zoom in or zoom out the image. The user can right-click the button of the mouse to disable this function. (NOTE: When using the mouse for operating digital zoom, the image can be zoom-in to max. 16x.)



E. PTZ CONTROLLER

In the live-viewing mode, click this button to call the PTZ control panel.

NOTE : Only for PTZ cameras.

PTZ CONTROL



Press the minimization icon then the control panel becomes smaller:



Move the mouse and the arrow will follow the mouse and change direction. In this mode user can click on the live view to control direction instead of the direction key on control panel.

If a fisheye camera is connected:

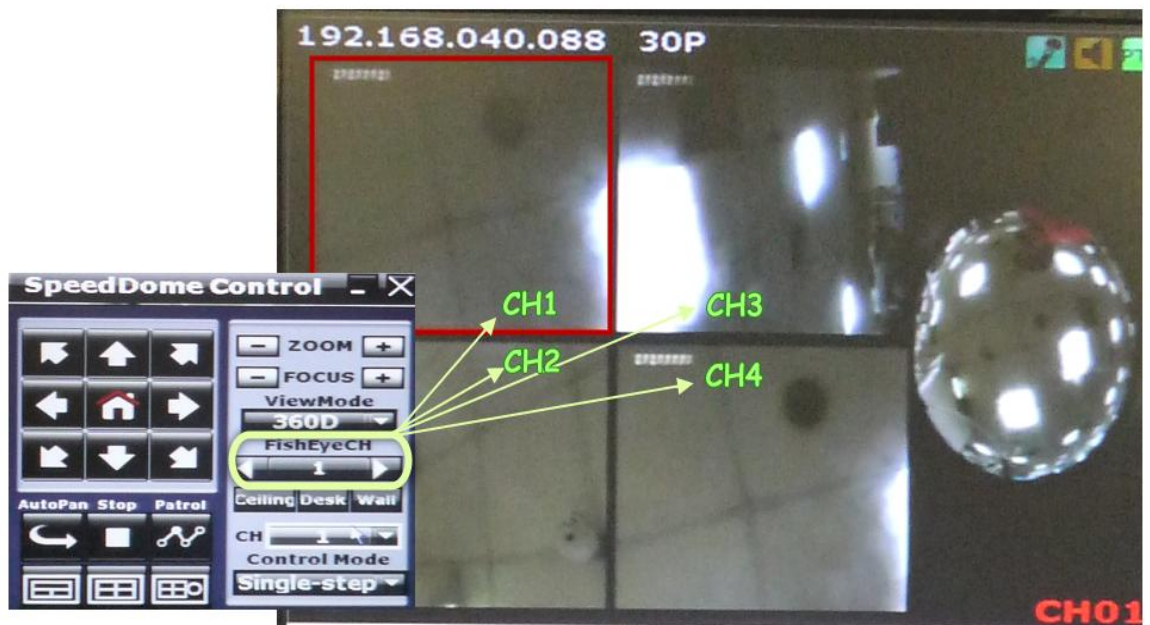

F-PTZ Steps:

- (1) Select the channel number you want to setup, if there are several ones.
- (2) Select the View Mode, 360 degree or 180 degree.
- (3) Select the camera location, ceiling, desk, or wall.
- (4) Select split screen pattern



: 360 degree panorama view + sub screens x4



: 180 degree flat view + sub screens x2



: sub screens x4

- (5) After you decide the screen pattern, use the fisheye channel list to select one of the sub screens. (as the green circle on the picture above). The selected one will be indicated in a red frame.
- (6) For the selected sub screen, use the 4-direction arrows and the “+” (zoom in) ”-” (zoom out) icon for E-PTZ control.
- (7) Control Mode: Select the E-PTZ moving mode, step by step or continuous.
- (8) The AutoPan, Stop, and Patrol buttons are invalid here if the fisheye camera doesn't support those function.

G. AUDIO VOLUME

Press this button, and the audio volume control board will pop up.

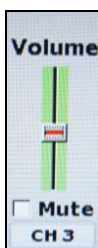

H. AUTO SWAP

Press it to start switch dwell. The interval depends on the setting in IP Cam Image Setup when it's on single channel view. For split screen the switch dwell interval is 5 sec.

I.  **DISPLAY CONTROL**

Within live-viewing or playback mode, use the display control to switch the camera channel.

J.  **RECORD AND PLAYBACK CONTROL**

The same as the front panel controller.



K.  **BROADCASTING**

Press the bottom to enable or disable the one way audio. Broadcasting can be applied to multiple channels simultaneously.

L.  **FULLSCREEN**

Press the bottom for full-screen mode.

M.  **SOUND INPUT/ SOUND OUTPUT / PTZ CONTROL**

There are little icon on the right top of the live vide of every channel. Click  to enable the two way audio. Click  to enable the sound output. Click the  button to call out the control board. Note that if those functions are not supported by the camera linked, you will not see the corresponding icons.

The sound options do not affect the audio recorded into the video. As long as the audio setup is enabled, the playback video includes audio even if the sound output is turned off.

N. RECORDING STATUS

Beneath the date and time, it displays the current recording type:

Record mode: Schedule – NO REC period	2012/10/15 MON 13:46:22 X 1%
Record mode: Schedule – ALARM REC period Record mode: Alarm trigger	2012/10/15 MON 13:46:47 A 1%
Record mode: Manual – Stop Recording	2012/10/15 MON 13:52:35 1%
Record mode: Schedule – FULL REC period Record mode: Manual – Recording	2012/10/15 MON 13:47:14 REC 1%



3.3 CAMERA SETUP



A. IP Cam Setup

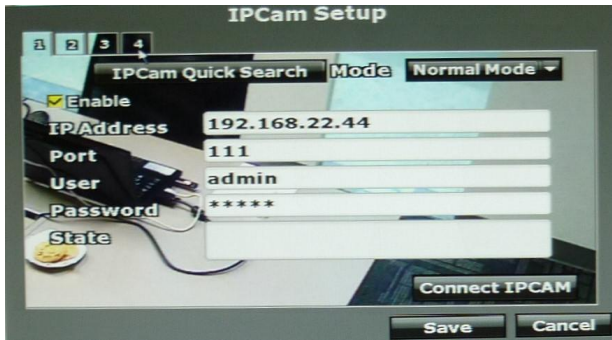

A-1. IP Cam Quick Search

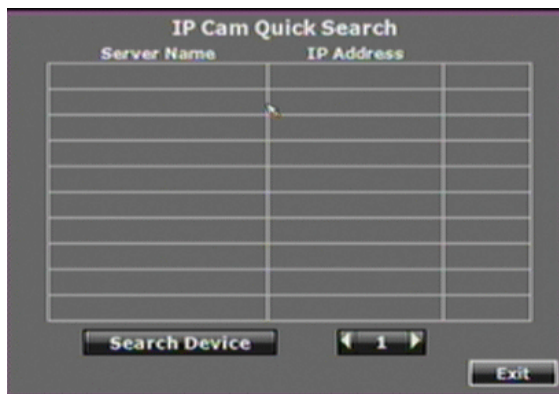

Press the “IP Cam Quick Search” button and click the “Search Device” button. The NVR will search the IP CAM devices which IP address are setup as the same domain as the NVR IP address. Moreover, by clicking on the IP Cam on the list will import the device information to the channel automatically without any manual key-in step.

The IP Cam has to be under the same LAN with NVR in order to be successfully connected. Ex. If the NVR IP address is 192.168.10.33, the IP Cam IP address should be 192.168.10.X. You can edit the IP Cam IP address here or on the IP Cam.

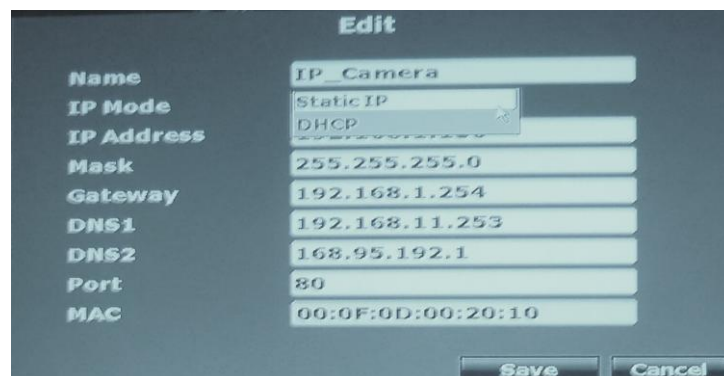

A-2. Normal Mode

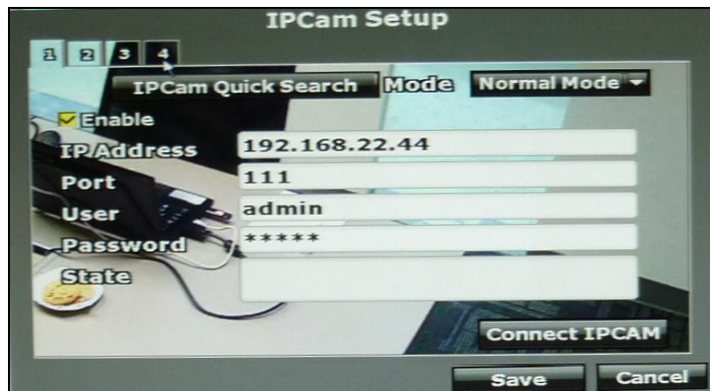

1. Enable: Choose “Normal Mode”
2. IP Address : Insert the IP address of the connecting device.
3. Port : Insert the port number of the connecting device. Default port: 80
4. User : Insert the user name of the connecting device.
5. Password : Insert the password of the connecting device.
6. State : After clicking the “connect IP CAM” button to test the IP CAM device, the connection state will reveal among this column.

Note: If the camera connected via ONVIF protocol, the PTZ control function will not be supported.

A-3. RSTP Mode

Under RTSP Mode, the NVR only support IP address indication, live video, and video recording. Other functions like motion detection are not supported.

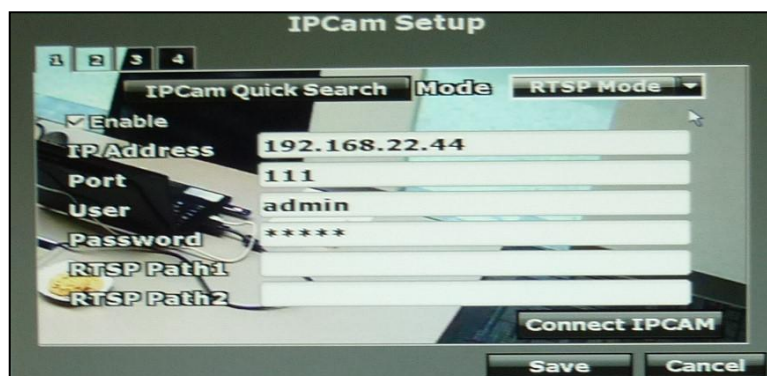

Key-in the IP address, port, username, and password of the device you are

connecting to the NVR. You can find the information on the IP Cam.

To link to the IP camera, check the RTSP Path settings of your IP camera, and key-in the corresponding values of two streams in “RTSP Path 1” and “RTSP Path 2”.

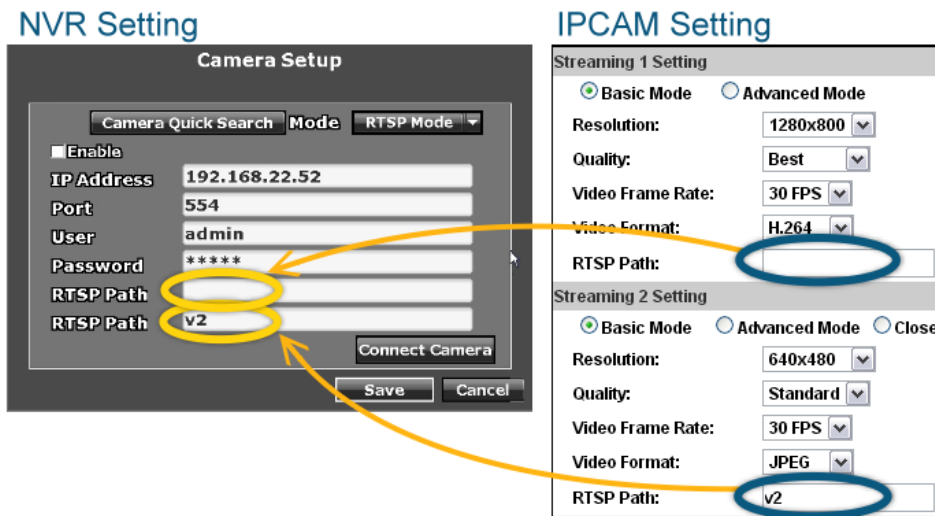

Note: When you select RTSP mode, make sure the substream resolution of camera is VGA(640x480), otherwise you will receive the warning message when you try to connect to the camera:

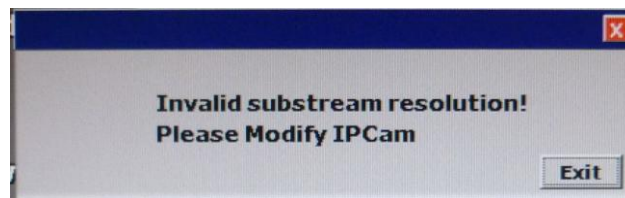

Examples of some RTSP settings:

RTSP Path 1 (IP Cam Main stream)	RTSP Path 2 (IP Cam Sub stream)	Result
1920 x 1080	640 x 480	OK. NVR takes 1920x1080 streaming for single channel view mode, and 640x480 streaming for split screen mode.
1920 x 1080	N/A (Fill in nothing on "RTSP Path 2")	Error Message: "Invalid Substream Resolution! Please modify IP Cam." NVR takes 1920x1080 streaming for both single channel view mode and split screen mode. However, it can only allow 640x480 resolution for split screen, so it shows a error in return.
640 x 480	N/A (Fill in nothing on "RTSP Path 2")	OK. NVR takes a 640x480 streaming for both single channel view mode and split screen mode.
N/A (Fill in nothing on "RTSP Path 1")	640 x 480	OK. NVR takes a 640x480 streaming for both single channel view mode and split screen mode.
640 X480	1920 x 1080	OK. NVR takes 1920x1080 streaming for single channel view, and 640x480 streaming for split screen.
1920 x 1080	1920 x 1080	Error Message: "Invalid Substream Resolution! Please modify IP Cam." NVR takes 1920x1080 streaming for both single channel view and split screen. However, it can only allow 640x480 resolution for split screen, so it shows error in return.

B. IP Cam Video Setup

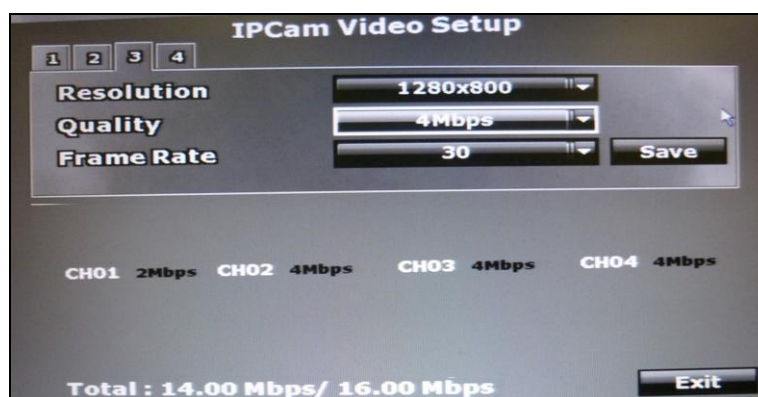

B-1. Resolution

Click the drop down list to change the resolution of connecting device.

B-2. Quality

Click the drop down list to change the image quality.

For H.264 IP Cam above 1 Megapixel, the resolution options support “1M, 2M, 4M, 6M, 8M”.

For H.264 IP Cam less than 1 Megapixel, the resolution options support” 2Mbps, 1.5Mbps, 1Mbps, 512Kbps, 256Kbps”

For MPEG IP Cam, the resolution options support “Standard, Medium, Low”. (The highest resolution option is “standard” due to the chip performance limits of IP Cam)

B-3. FrameRate

Click drop down list to change the frame rate of connecting device.

C. IP Cam Image Setup

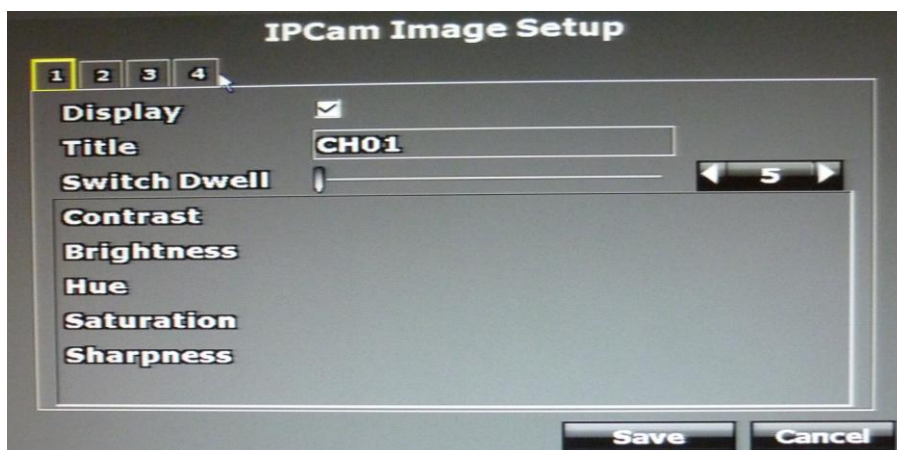

C-1. Display

Use the mouse to enable or disable the camera display on the screen.

C-2. Title

Use the mouse to setup the title of the connecting IP device.

C-3. Contrast

Press ◀ or ▶ to change contrast level. The adjustment value is between 0~255

C-4. Brightness

Press ◀ or ▶ to change brightness level. The adjustment value is between 0~255

C-5. Hue

Press ◀ or ▶ to change hue level. The adjustment value is between 0~255

C-6. Saturation

Press ◀ or ▶ to change saturation level. The adjustment value is between 0~255

C-7. Sharpness

Press ◀ or ▶ / mouse wheel to change sharpness level. The adjustment value is between 0~15

C-8. Switch Dwell

Press ◀ or ▶ to change auto switch second. The value is between 0~99 sec.

D. Motion Setup

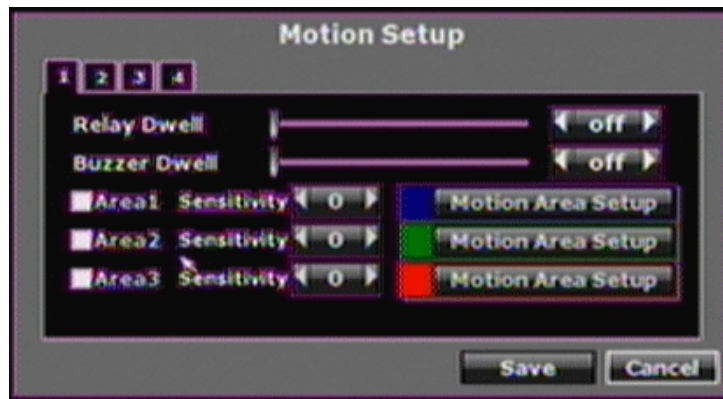

D-1. Relay Dwell

Press ◀ or ▶ to change the relay time or disable the relay function.

D-2. Buzzer Dwell

Press ◀ or ▶ to change the buzzer time or disable the buzzer function.

D-3. Area1 Sensitivity

Press ◀ or ▶ to change the sensitivity of setup motion area in Area1. Click “Motion Area Setup” and drag a blue area for motion detection.

D-4. Area2 Sensitivity

Press ◀ or ▶ to change the sensitivity of setup motion area in Area2. Click “Motion Area Setup” and drag a green area for motion detection.

D-5. Area3 Sensitivity

Press ◀ or ▶ to change the sensitivity of setup motion area in Area3. Click “Motion Area Setup” and drag a red area for motion detection.



After dragging an area, right-click and select “Exit with saving” to complete the area setup.

Select “Enable All” to set up global motion detection.

Select “Clean All” to clean the area of the current color in the view.

Select “Exit Without Saving” to go back to motion setup menu and not saving any change.

E. Mask Setup

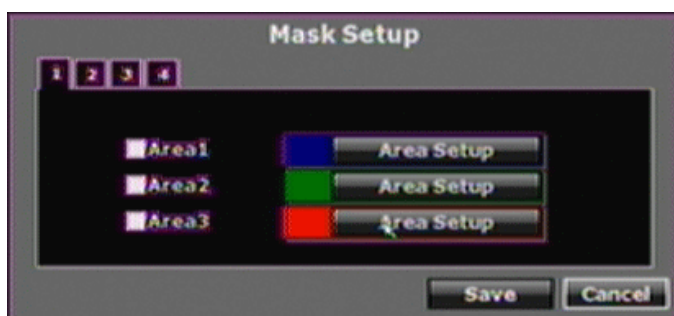

The masked area will not show both in the live view and playback recording.

E-1. Area1

Tick the “Area1” box and click “Area Setup” to drag a blue area for masking.

E-2. Area2

Tick the “Area1” box and click “Area Setup” to drag a green area for masking.

E-3. Area3

Tick the “Area1” box and click “Area Setup” to drag a red area for masking.



After dragging an area, right-click the mouse, select “Exit with saving” to complete the area setup.

Select “Enable All” to set up global masking.

Select “Clean All” to clean the area of the current color in the view.

Select “Exit Without Saving” to go back to the mask setup menu without saving any change.

F. IP Cam Audio Setup

The channel ticked means the sound from camera will be recorded into the playback video. On the contrary, no sound will be recorded in the playback video of the channel which is not ticked.

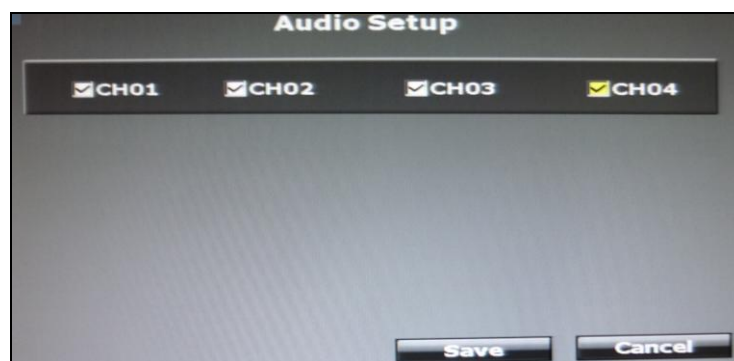

G. Quick Setup

Other than “IP CAM Setup”, you can choose another way to complete the IP camera connection job: using Quick Setup.

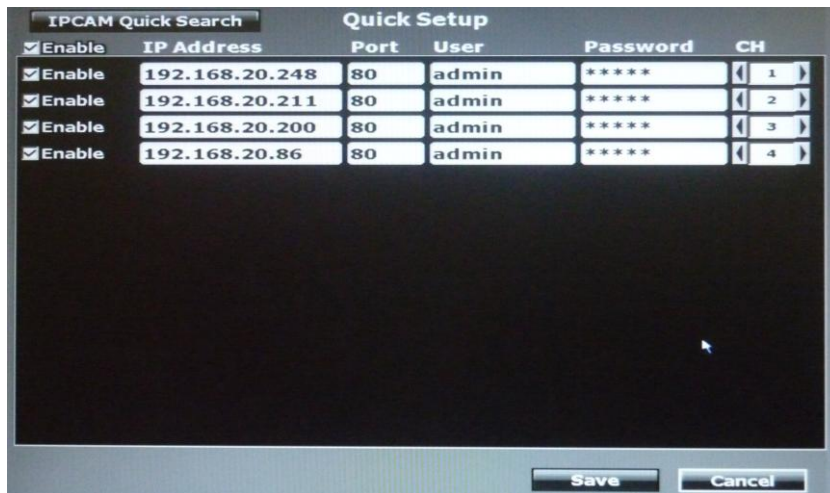

G-1 Key-in information manually

The whole channel list are displayed. You can key-in the IP address, port, and user name & password of the IP camera, and then assign the channel number. Tick “Enable” to connect to the IP camera.

G-2 IP CAM Quick Search

With Quick Search, you do not need to type the IP address. Click “IP CAM Quick Search” to enter the search menu.



The machine searches for all the IP devices listed under the LAN. Find the IP camera you want to connect to, assign a channel number for it, and tick “Enable” so for enabling this IP camera and adding it to the all-channel list.

Back to the all-channel list, you can key-in the user name and password, and tick “Enable” to connect to the camera.

If you want to revise the IP setting of a camera, click “Edit”:

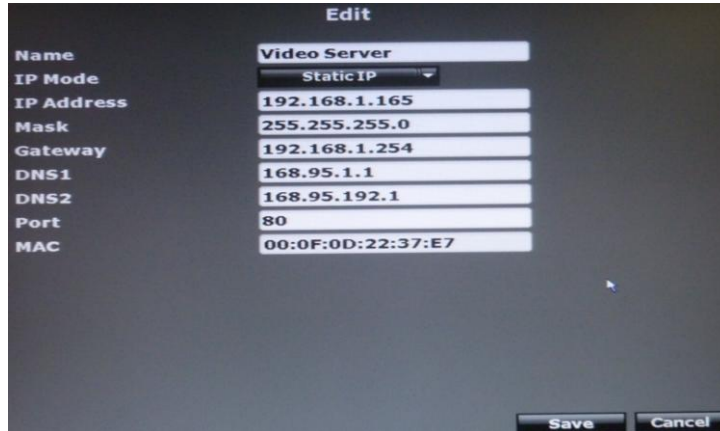

Field	Value
Name	Video Server
IP Mode	Static IP
IP Address	192.168.1.165
Mask	255.255.255.0
Gateway	192.168.1.254
DNS1	168.95.1.1
DNS2	168.95.192.1
Port	80
MAC	00:0F:0D:22:37:E7

The IP Cam has to be under the same LAN with NVR in order to connect successfully. Ex. If the NVR IP address is 192.168.10.33, the IP Cam IP address should be 192.168.10.X. You can edit the IP Cam IP address here or on the IP Cam.



3.4 RECORD SETUP



Field	Value
Pre-Alarm Record Time	10 Sec
Post-Alarm Record Time	10 Sec
Record Mode	Manual

A. Pre-Alarm Record Time / Post-Alarm Record Time

Pre-alarm record means the recording before the alarm is triggered; the post-alarm record means the recording after the alarm is triggered. If you set 5 sec for pre-alarm and 5 sec for post-alarm, the alarm recording length will be total 10 sec.

B. Record Mode

The record mode will be applied to all channels simultaneously. When recording, the NVR record both main streaming and sub streaming from IP Cam. Use the drop down list to switch the recording mode.

1. Manual: Click  to start recording. Click  to stop recording.

2. Schedule:

a. Schedule Setup:

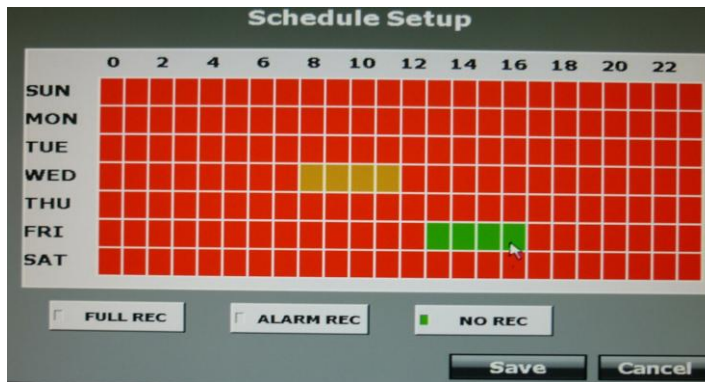

Click the tag “Full Recording”(Red) / “Alarm Recording”(Yellow) / “No Recording”(Green), and then draw on the calendar. The recording type will follow the schedule.

The tag “Alarm Recording” includes all the alarm types.

b. Mail Schedule Setup:

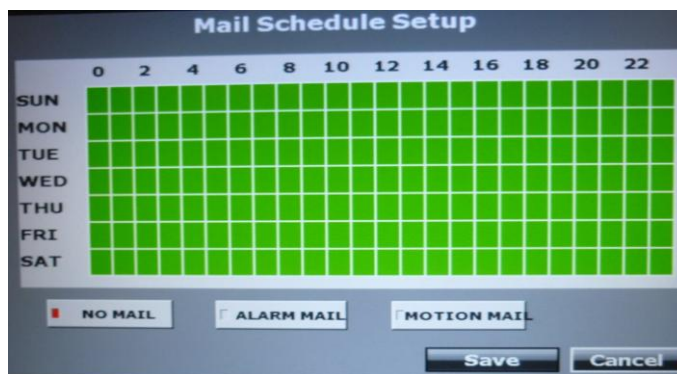

Select the time that the recording video is sent to the mail address. No mail will be sent during the “NO MAIL” time period even if the motion detection is triggered. The tag “ALARM MAIL” refers to both external alarm and DI from camera.

c. FTP Schedule Setup:

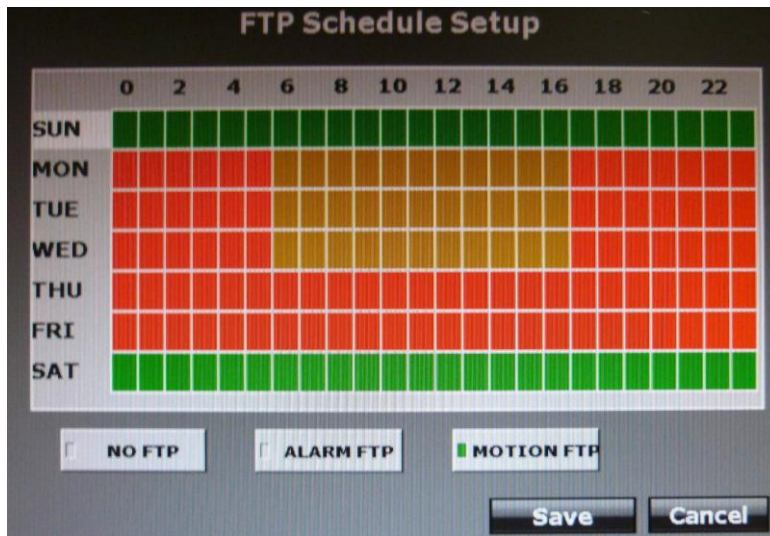

Select the time that the recording video is uploaded to FTP. No file will be uploaded during “NO MAIL” time period even the motion detection is triggered.

The tag “ALARM FTP” refers to both external alarm and DI from camera.

3. Alarm Trigger: Start recording when any type of alarm event occurs. The recording video length is according to the setting of “Pre-Alarm Record Time” or “Post-Alarm Record Time”.

C. Mobile Streaming Setup

Choose “ON” to record the streaming for mobile viewing.

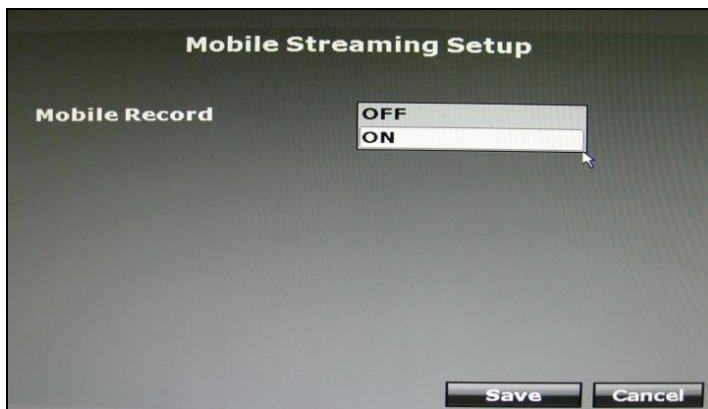

3.5



ALARM SETUP

A. Alarm Trigger Setup



Use the drop down list to switch the alarm auto switch. When the alarm is triggered, the screen will switch to full screen, split screen (4CH split screen) or disable.

A-2. Video Loss Detection

Use the drop down list to switch the video loss detection. When the video loss is detected, the alarm will be triggered.

A-3. Digital Input (IP Cam)

Use the drop down list to switch on /off the Digital Input from IP camera. When the DI signal is received from the camera, the alarm will be triggered.

A-4. Ext. Alarm Detection

Use the drop down list to switch the external alarm detection. When the external alarm is detected, the alarm will be triggered.

A-5. Ext. Alarm Mode

Use the drop down list to switch the external alarm mode. If the external alarm is setup for normal open, the option has to switch to N.O.; for the contrary, the option has to switch to N.C.

B. Alarm Output Setup



Alarm Output Setup

Buzzer Time
Ext. Alarm Buzzer Time: ◀ 5 ▶ Sec
Video Loss Buzzer Time: ◀ 5 ▶ Sec

Relay Time
Ext. Alarm Relay Time: ◀ 5 ▶ Sec
Video Loss Relay Time: ◀ 5 ▶ Sec

Save Cancel

This control item is divided into two parts, “Buzzer Time” and “Relay Time”. The user can press ◀ or ▶ to switch the external buzzer time and video loss buzzer time in “Buzzer Time” option. The adjustment value is from 5 to 99 seconds. Moreover, among “Relay Time” option, the user can press ◀ or ▶ to switch the external buzzer time and video loss buzzer time. The adjustment value is from 5 to 99 seconds as well.

The Value of Ext. Alarm Buzzer / Relay Time determine the buzzer / relay time of both external alarm in and digital input (IP Cam).

C. Alarm Event Setup



Alarm Event Setup





<input checked="" type="checkbox"/> Power On Event	<input checked="" type="checkbox"/> Power Off Event
<input checked="" type="checkbox"/> Video Loss Event	<input checked="" type="checkbox"/> Motion Event
<input checked="" type="checkbox"/> Record Event	<input checked="" type="checkbox"/> Stop Record Event
<input checked="" type="checkbox"/> Digital Input Event	<input checked="" type="checkbox"/> Ext. Alarm Event

Save Cancel

There are eight types of events that can be selected. When the selected items occur and triggered, the log will be recorded in the event playback list.

D. Alarm Action and Trigger Condition List

Action \ Type	Motion detection	External Alarm	DI (IP CAM)	Video Loss
Necessary Condition (All the actions below can be execute only when the necessary condition is met.)	Camera Setup >>Motion Setup >>Tick "Area 1/2/3" and set up the area	Alarm Setup >>Alarm Trigger Setup >>"Ext. Alarm Detection" set to "Enable"	Alarm Setup >>Alarm Trigger Setup >>"Digital Input (IP Cam)" set to "Enable"	Alarm Setup >>Alarm Trigger Setup >>"Video Loss Detection" set to "Enable"

Action \ Type	Motion detection	External Alarm	DI (IP CAM)	Video Loss
Switch to Single Channel Screen / Split Screen	Condition: Alarm Setup >>Alarm Trigger Setup >>"Alarm Auto Switch" set to "Full Screen(/Split Screen)"	X	X	X
Trigger Relay/ Buzzer	Condition: Camera Setup >>Motion Setup >>"Relay(/Buzzer) Dwell" not set to "Off"	(It's enabled as long as the necessary condition is meet) *p: Trigger length setting: Alarm Setup >>Alarm Output Setup >>Relay(/Buzzer) Time *p : "Ext. Alarm Relay(/Buzzer) Time" length setting determines the trigger length of both "External Alarm" and "DI(IP CAM)"		
Written in Log (Can be used for event search playback)	Condition: Alarm Setup >>Alarm Event Setup >>Tick "Motion Even" / "Ext. Alarm Event" / "Digital Input Event" / "Video Loss Event"			
Icon on Live Screen				

Action \ Type	Motion detection	External Alarm	DI (IP CAM)	Video Loss
Pre- / Post-alarm Recording	O			Pre-:O Post-:X
Send E-mail / Upload to FTP with Pre-/ Post-alarm Recording (*p[1])	<p style="text-align: center;">Condition 1: Network Setup >>Mail(FTP) Setup >>Tick "Motion(/Alarm)"; And Record Setup >>"Record Mode" set to "Manual"; And it's on recording when alarm is triggered</p> <p style="text-align: center;">Condition 2: Network Setup >>Mail(FTP) Setup >>Tick "Motion(/Alarm)"; And Record Setup >>"Record Mode" set to "Alarm Trigger"</p> <p style="text-align: center;">Condition 3: Record Setup >>"Record Mode" set to "Schedule"; And Record Setup >>Schedule Setup >>It's on "Full Rec" or "Alarm Rec" period when alarm is triggered; And Record Setup >>Mail(FTP) Schedule Setup >>It's on "Motion(/Alarm) Mail(FTP)" period when alarm is triggered <u>※It's enabled when both necessary nondition and one of above three conditions are met.</u></p> <p style="text-align: center;">*p: Mail/FTP server setting: Network Setup>>Mail(FTP) Setup>>Fill in server information</p> <p style="text-align: center;">*p: Pre-/ Post-alarm recording length setting: Record Setup>>Pre/(Post)-Alarm Record Time</p>			X
Http CGI	Network Setup>>HTTP Notification Setup>>Fill in Http server information and tick "Enable"			

***p[1]: Another interpretation:**

Send E-mail / Upload to FTP with Pre-/ Post-alarm Recording	<p style="text-align: center;">Condition 1: Record Setup >>"Record Mode" set to "Manual" or "Alarm Trigger". It's not on "Stop Rec" period; And Network Setup >>Mail(FTP) Setup >>Tick "Motion(/Alarm)"</p> <p style="text-align: center;">Condition 2: Record Setup >>"Record Mode" set to "Schedule". It's not on "No Rec" period; And Mail(FTP) Schedule Setup >> It's not on "No Mail(FTP)" period <u>※It's enabled when both Necessary Condition and one of above two conditions are met.</u></p>
--	---

3.6



NETWORK SETUP

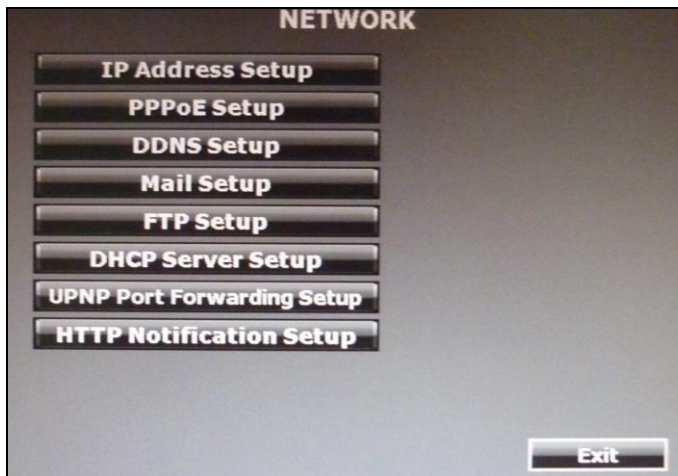

A. IP ADDRESS SETUP



A-1. IP Mode

Press drop down list to change IP mode to Static IP or DHCP.

A-2. IP Address

Give the NVR IP Address.

A-3. NetMask

Give the subnet mask which we usually set to 255.255.255.0

A-4. Gateway

Give NVR gateway.

A-5. DNS1 & DNS2

Key-in DNS1 and DNS2 that provided by ISP.

A-6. Default Gateway

Decide LAN1 setting or LAN2 setting to be default gateway.

A-7. WebPage Port

Give the NVR http port for web browser. Default is 80.

B. PPPoE SETUP

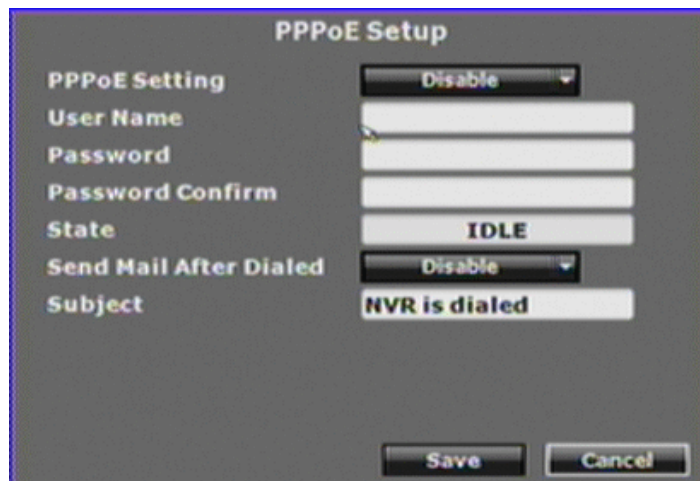

PPPoE Setup

PPPoE Setting: Disable

User Name: [Empty]

Password: [Empty]

Password Confirm: [Empty]

State: IDLE

Send Mail After Dialed: Disable

Subject: NVR is dialed

Save Cancel

B-1. PPPoE Setting

Press the drop down list to enable or disable PPPoE.

B-2. User Name

Insert the user name (ADSL account) which provided from local ISP.

B-3. Password

Insert the password which provided from local ISP.

B-4. Password Confirm

Insert the password again to confirm the password.

B-5. State

Present the current status of PPPoE function.

B-6. Send Mail After Dialed

Click the drop down list to enable or disable the function.

B-7. Subject

Insert the mail subject when dialed successfully.

C. DDNS SETUP

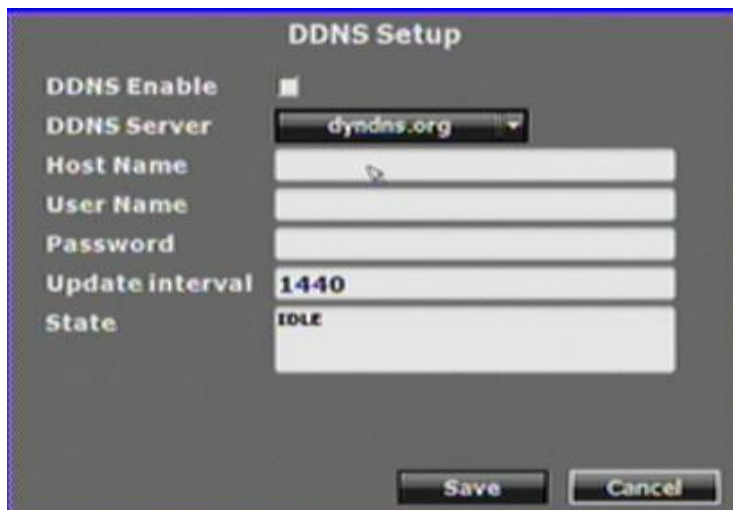

The image shows a screenshot of a 'DDNS Setup' configuration window. The window has a title bar and a list of settings on the left side. The settings and their values are as follows:

Setting	Value
DDNS Enable	<input checked="" type="checkbox"/>
DDNS Server	dyndns.org
Host Name	
User Name	
Password	
Update interval	1440
State	IDLE

At the bottom of the window, there are two buttons: 'Save' and 'Cancel'.

C-1. DDNS Enable

Click the checkbox to enable or disable the DDNS function.

C-2. Provider

Click the drop down list to select the DDNS provider.

C-3. Host Name

Insert the registered host name in the selected provider.

C-4. User Name

Insert the registered user name in the selected provider.

C-5. Password

Insert the registered password in the selected provider.

C-6. Update Interval

A period of time to update IP address.

C-7. State

The state after apply for DDNS.

Updating: Information update.

Idle: Stop service.

DDNS registered successfully, now log by

<http://<username>.ddns.camddns.com>: Registered successfully.

Updating Failed: the name is already registered.

Updating Failed: please check your internet connection.

D. MAIL SETUP

Mail Setup

Enable **Event Mail**

Mail Server: smtp.domain.com

SMTP Port: 465

Username: hello780904

Password: *****

Sender's Mail: abcdef@domain.com

Receiver's Mail: hzyx@domain.com

BCC Mail:

Subject: ALARM TRIGGER!

Secure Connection

Test Save Cancel

D-1. Enable

Tick “Alarm” to send video to the mail address when external alarm or DI from IP Cam is triggered. Tick “Motion” to send video to the mail address when motion detection is triggered.

D-2. Mail Server

The IP address of Mail Server

D-3. SMTP Port

The port of SMTP (known as Simple Mail Transfer Protocol). (Default value is 25)

D-4. Username

The user name while log in to the mail server.

D-5. Password

The password while log in to the mail server.

D-6. Sender's Mail

The sender's account when send the mail via this mail server.

D-7. Receiver's Mail

The receiver's mail address.

D-8. BCC Mail

The receiver's mail address for Bcc Mail.

D-9. Subject

The subject while sending the mail.

D-10. Secure Connection

When ticked the user can choose between SSL or TSL

E. EVENT MAIL SETUP

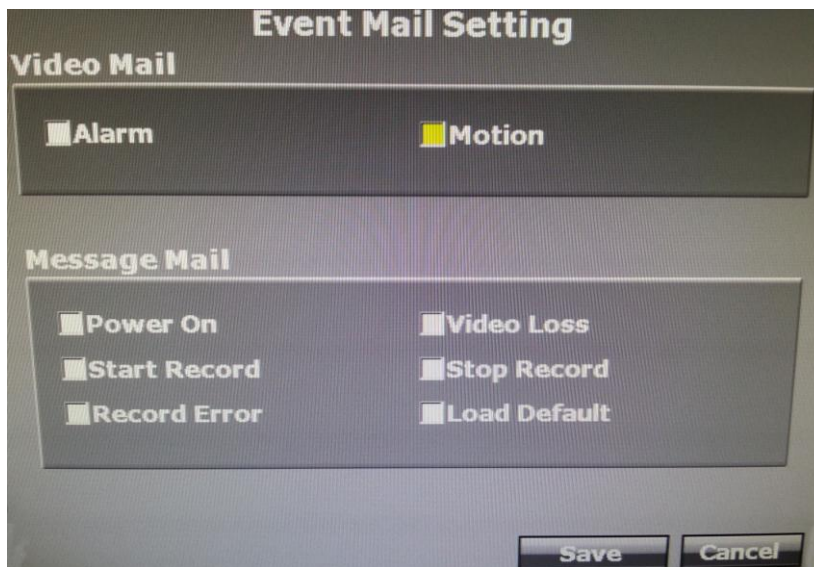

E-1. Alarm / Motion

Sends a video notification via email for Alarm-in and/or Motion detection

E-2. Power On

Will send a notification via email when the NVR starts or reboots.

E-3. Start Record

Will send a notification via email when the NVR starts recording.

E-4. Record Error

Will send a notification via email when the recording failed (usually represents hardware failed in the HDD).

E-5. Video Loss

Will send a notification via email when the image is lost or the Internet connection is lost.

E-6. Load Default

Will send a notification via email when the NVR load the default settings.

F. FTP SETUP



The screenshot shows the 'FTP Setup' configuration window. It includes the following elements:

- Enable:** Two checkboxes labeled 'ALARM' and 'MOTION'.
- FTP Server:** A text input field.
- Username:** A text input field.
- Password:** A text input field.
- FTP Port:** A text input field containing the value '21'.
- Path:** A text input field containing the value '/ALARM/'.
- Buttons:** 'Save' and 'Cancel' buttons at the bottom right.

F-1. Enable

Tick “Alarm” to upload video to FTP when external alarm or DI from IP Cam is triggered. Tick “Motion” to upload video to FTP when motion detection is triggered.

F-2. FTP Server

The IP address of FTP Server.

F-3. User Name

The username while log in to the ftp server.

F-4. Password

The password while log in to the ftp server.

F-5. FTP Port

The port number of file transmission. (Default value is 21)

F-6. Path

The ftp path where the user wants to save the information.

G. DHCP Server Setup



DHCP Server Setup

Enable

Start IP Address 192.168.1.20

End IP Address 192.168.1.100

Lease Time 10 Day

Save Cancel

G-1. Enable

Use the checkbox to enable or disable the DHCP Server function. When the function is activated, the NVR can be act as the DHCP server. The NVR will assign or distribute one of the IP address which is according to the setup IP address range (start and end IP Address.) to the connecting IP CAM (setup DHCP function as well).

G-2. Start IP Address

Use the virtual keypad to insert the start IP Address of DHCP server.

G-3. End IP Address

Use the virtual keypad to insert the end IP Address of DHCP server.

G-4. Lease Time

Press ◀ or ▶ to change the lease time of DHCP server.

H. UPNP Port Forwarding Setup



The screenshot shows a dialog box titled "UPNP Port Forwarding Setup". It contains three settings: "Enable" with a checked checkbox, "External HTTP Port" with a text box containing "80", and "External RTSP Port" with a text box containing "554". At the bottom right, there are "Save" and "Cancel" buttons.

H-1. Enable

Use the checkbox to enable or disable UPNP port setup.

H-2. External HTTP Port

Use the virtual keypad to insert the external http port.

H-3. External RTSP Port

Use the virtual keypad to insert the external RTSP port.

I. HTTP Notification Setup

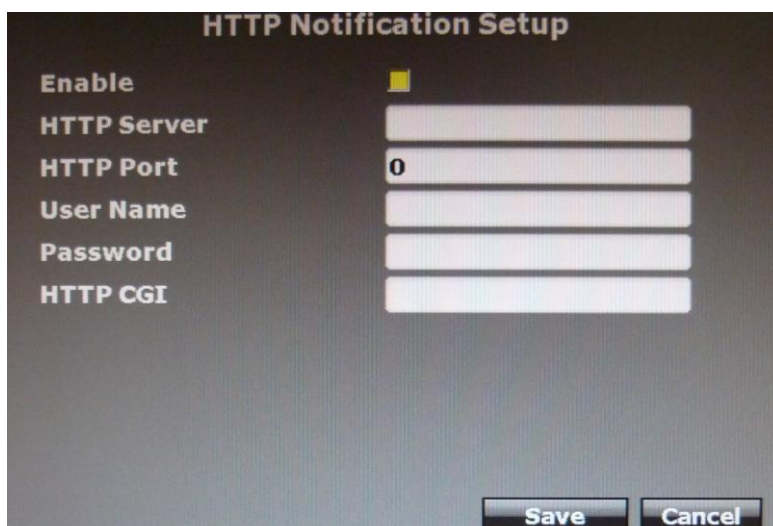

The screenshot shows a dialog box titled "HTTP Notification Setup". It contains six settings: "Enable" with a checked checkbox, "HTTP Server" with an empty text box, "HTTP Port" with a text box containing "0", "User Name" with an empty text box, "Password" with an empty text box, and "HTTP CGI" with an empty text box. At the bottom right, there are "Save" and "Cancel" buttons.

I-1. Enable

Use the checkbox to enable or disable HTTP Notification. This function allows users to set up the CGI command to a HTTP server. The server can be any device that can receive CGI via HTTP protocol. When any alarm events occur, the NVR sends the CGI to that server.

I-2. HTTP Server

Key-in the server IP address.

I-3 HTTP Port

Key-in the server port used for http protocol.

I-4 User Name

Key-in the server username.

I-5 Password

Key-in the server password.

I-6 HTTP CGI

Key-in the CGI that you would like to send to the server when alarm events occur.

3.7



AUTHORITY SETUP

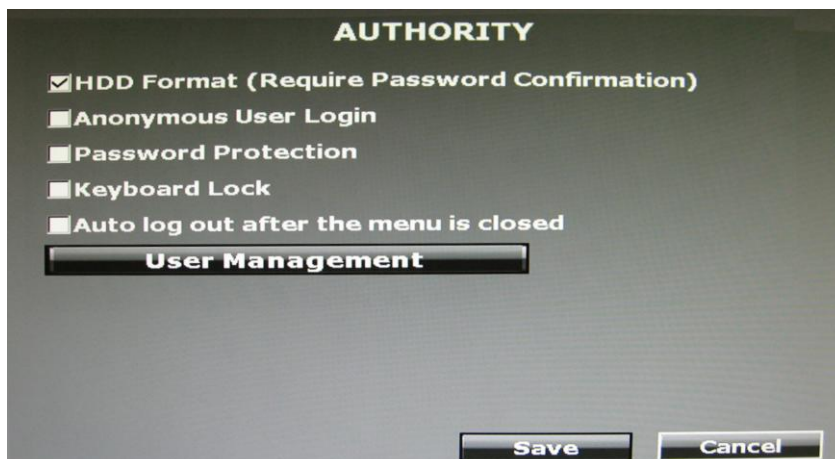

A. HDD Format

Use the checkbox to enable or disable the authority of the HDD Format function. If this function is enabled, the user has to insert the password while performing the HDD formatting.

B. Anonymous User Login

Use the checkbox to enable or disable the authority of the anonymous user login. If enable this function, the user does not have to insert the username/ password and will view the live image via IE browser.

C. Password Protection

Use the checkbox to enable or disable the authority of password protection.

D. Keyboard Lock

Use the checkbox to enable or disable the operation of the control bar which is in the right hand side of live view. The control bar can not work when the keyboard lock is activated.

E. Auto Logout

Use the checkbox to enable or disable the operation. If enabled, the system will log out automatically after the menu closed.

F. User Management

The administrator can setup the user management permission and the user authority management.



F-1. Permission

Use the mouse for clicking the checkbox to modify and alter the user authority.



The screenshot shows the 'User Management' window for user 'admin'. The user number is '1'. The 'User' field contains 'admin', and both 'Password' fields are filled with six asterisks. A mouse cursor is hovering over the 'REC ON/OFF' checkbox. All other checkboxes (Network LogIn, Play/Event, Camera Setup, Network Setup, PTZ, Record Setup, Disk Setup, Backup, MENU Setup, Alarm Setup, System Setup) are checked. Under 'Masking Channels in Playback and Network:', the checkboxes for CH01, CH02, CH03, and CH04 are unchecked. 'Save' and 'Cancel' buttons are at the bottom right.

F-2. Add User

After clicking the **Add User** button, the setup page will be called-out as the following. The administrator can distribute the authority and the permission for the new user.

(6 channels model)



The screenshot shows the 'User Management' window for user 'USER2'. The user number is '2'. The 'User' field contains 'USER2', and both 'Password' fields are empty. A mouse cursor is hovering over the 'REC ON/OFF' checkbox. All other checkboxes (Network LogIn, Play/Event, Camera Setup, Network Setup, PTZ, Record Setup, Disk Setup, Backup, MENU Setup, Alarm Setup, System Setup) are checked. Under 'Masking Channels in Playback and Network:', the checkboxes for CH01, CH02, CH03, and CH04 are unchecked. 'Save' and 'Cancel' buttons are at the bottom right.

3.8



DISK MANAGEMENT



A. Overwrite Mode

Select “ON” for the oldest recording data to be overwritten by new recording data. Select “OFF” for the NVR stop writing recording data into HDD when the HDD is full.

B. Hard Disk Full Warning

Under non-overwrite mode, click the drop down list to change value to 20%/ 15%/ 10% or 5% . When the HDD space is less than the setting ratio, the buzzer will start buzzing.

C. Auto Deletion

If select “ON” the users cannot find the recording data that is older than the reserve day.

For example:

On 2012/10/19 17:40. The auto deletion is set as “ON”. The reserve day are set as 3.

If the recording data is older than 2012/10/16 17:40 will not be indicated on the playback menu.

D. Reserve Day

Use ◀ or ▶ to setup the saving days day between 1~30 days.

Note: If the “Overwrite Mode” is set OFF and the NVR keeps recording, the HDD will finally get full regardless if “Auto Deletion” is ON.

E. Storage Information

The information of storage device will present in this page.



The screenshot shows a 'Storage Information' window with two tables. The first table, 'Hard Disk Device List', has four columns: DISK, CAPACITY, LEFT, and TEMP., with four rows of 'NON' in the DISK column. The second table, 'USB Device List', has three columns: DISK, CAPACITY, and LEFT, with one row of 'NON' in the DISK column. An 'Exit' button is located at the bottom right.

DISK	CAPACITY	LEFT	TEMP.
NON			
NON			
NON			
NON			

DISK	CAPACITY	LEFT
NON		

F. Format HDD

Insert the user name and password while performing the HDD format function.

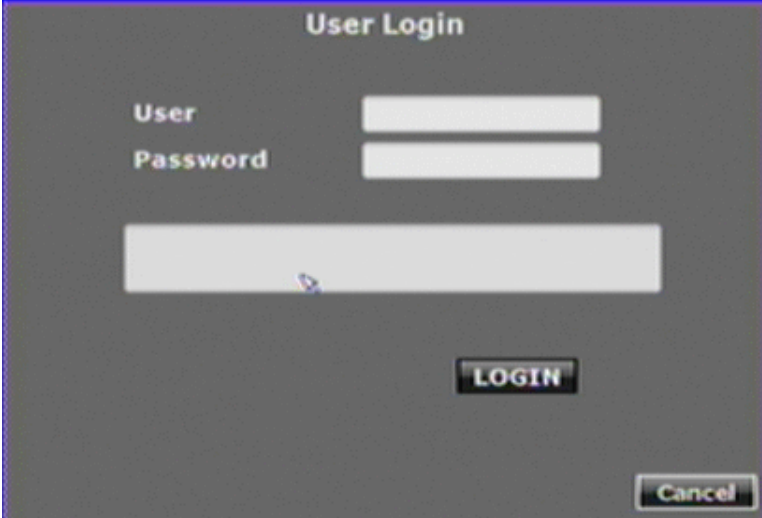

The screenshot shows a 'User Login' window. It contains three input fields: a small one for 'User', another for 'Password', and a large, wide one below them. At the bottom, there are two buttons: 'LOGIN' and 'Cancel'.



3.9 SYSTEM SETUP



A. NVR Name

Use the virtual keypad to insert the name of the NVR.

B. NVR ID

Use ◀ or ▶ to setup the NVR ID. The adjustment value is between 0~32

C. Language

Use the drop down list to change the NVR language. Currently, there are English, Traditional Chinese and Simplified Chinese as the available three options.

D. Date Format

Use the drop down list to change DATE. There are three modes: DD/MM/YYYY, YYYY/MM/DD and MM/DD/YYYY.

E. Version

The firmware version of the NVR will show in this column.

F. Software Update

Click  button to perform firmware updating.

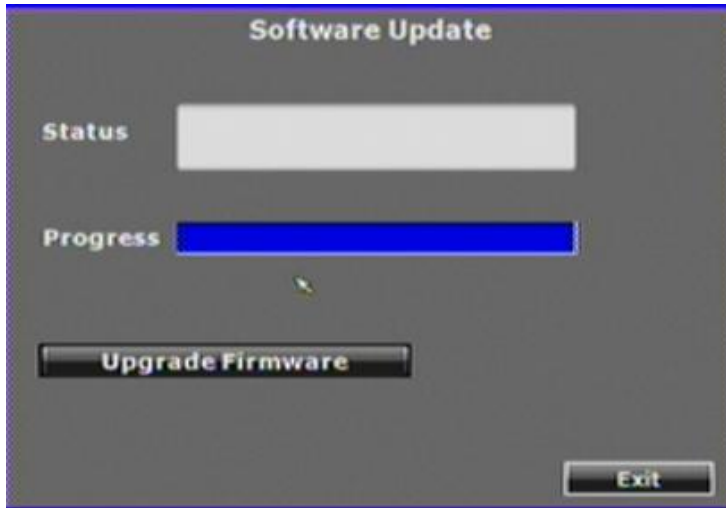

G. Configure Setup

Click the checkbox to select which item can be setup by the user. The user can also load the setting to factory default, load the configuration from USB and backup configure to USB.

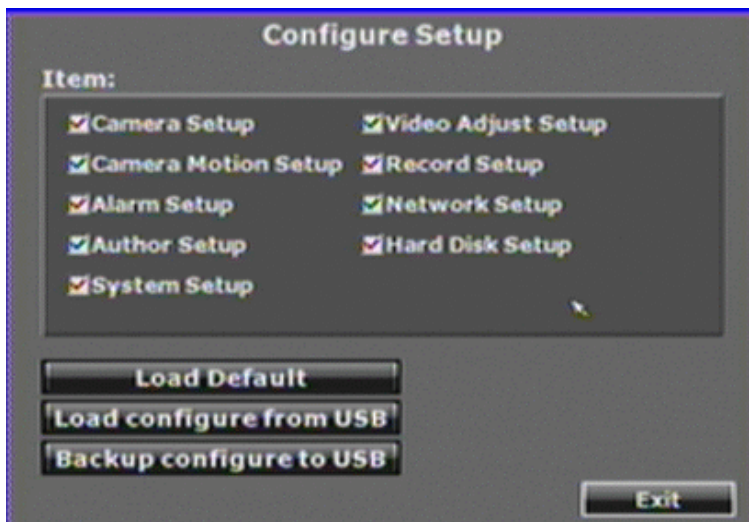

H. Time Setup



Click the **Set** button within the “Time” block for adjusting and synchronize the time of the NVR as the system time of the PC once. Moreover, if the user clicks the enable checkbox and the **Set** button in the within the “NTP Setup” block, the time of the NVR will be synchronized as the NTP Server every specific amounts of hours; specified on “Time Update”.

I. Day Light Saving Time

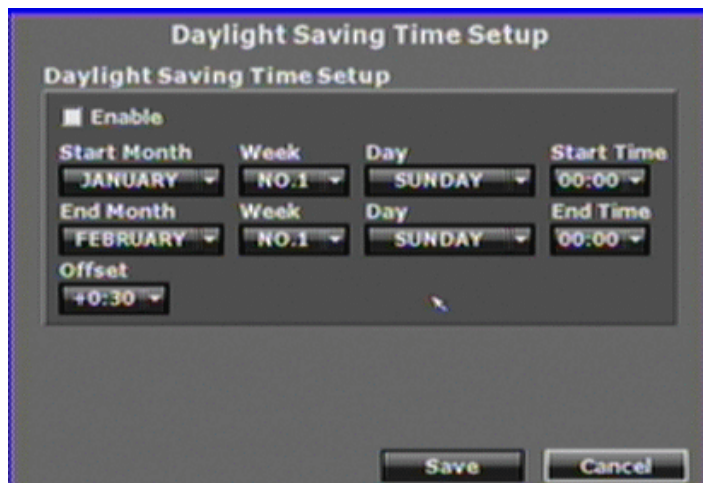

After enabling the daylight saving time function, the user can use the drop down list to select the start time and the end time of daylight saving time. After complete the setting, please click the **Save** button to save the settings.

J. Status Display Setup

Use the mouse to click the options, which are including “Date and Time Display”, “Record Information Display” and “Camera Title Display”.

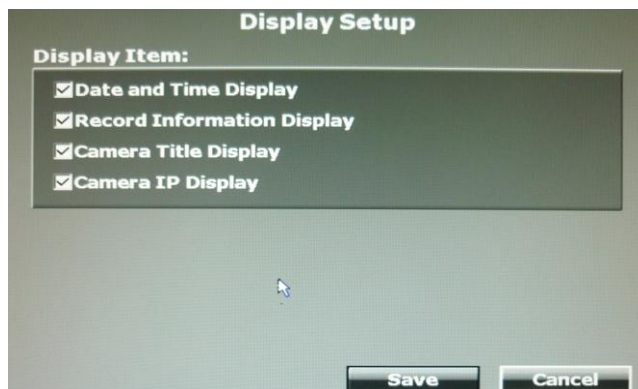

K. Monitor Adjust

The user can use ◀ or ▶ to adjust the monitor settings: “Brightness”, “Contrast”, “Hue” and “Saturation”.

The Resolution can be adjusted. Please check the frame rate that your LCD monitor support before any adjustment. If you select a resolution not compatible with the LCD monitor, the system will automatically undo the recent changes.

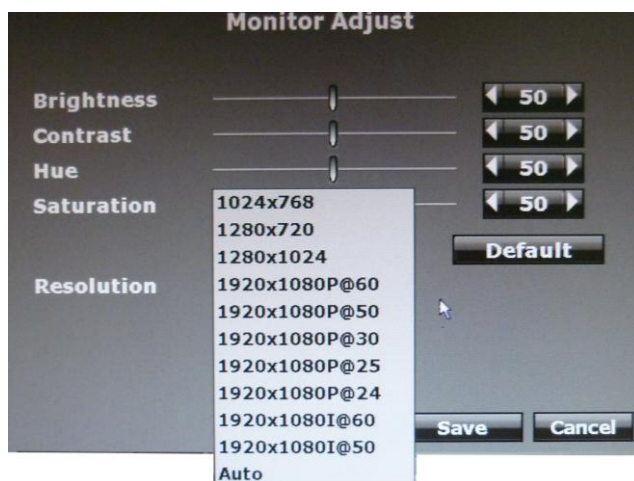

3. EX  **DEBUG MESSAGE**

dbgms
WinRAR 壓縮檔
24,708 KB

The purpose of the following procedure is to export a HDD debug message file. If the user has problems with the NVR, the technician can analyze the file and find the cause of problem.

- Plug in a USB disk.
- Enter the Authority Setup page and make sure the option “HDD Format (Require Password Confirmation)” is ticked.

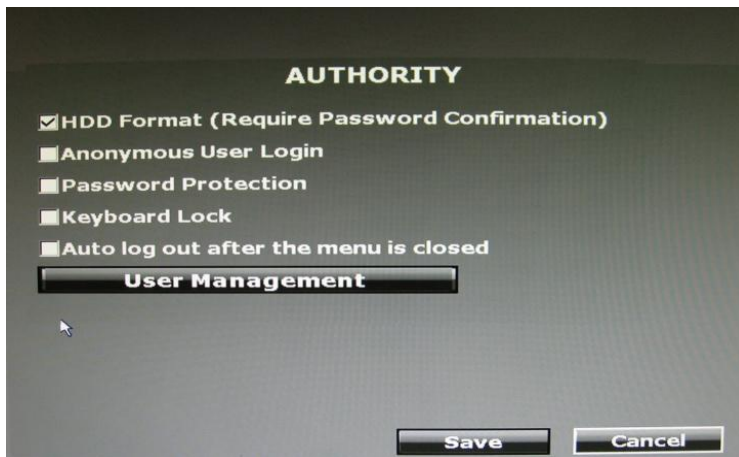

- Enter the Disk Setup page. Click “Format HDD”.

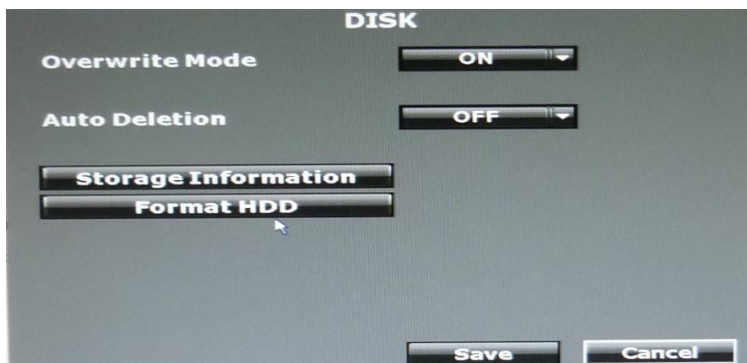

- Key-in “@k” in the user name column to login. No password is required.

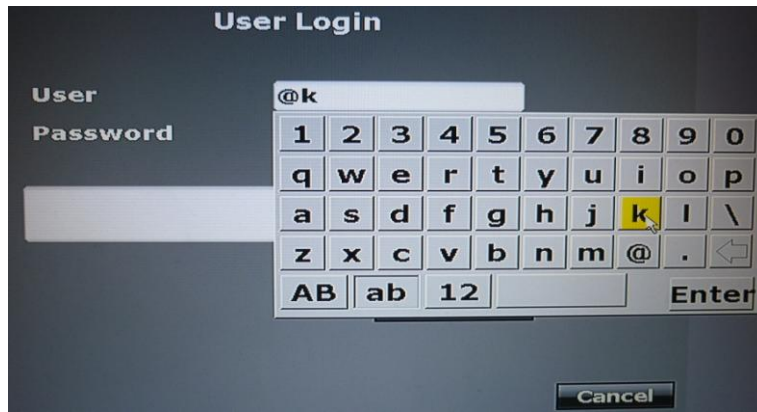

- The screen turns to the Advance Setup page. Click download. It takes about 10 seconds to export the file.



- When the downloading is complete, a message pops up to remind the user. Click "OK".



- Now the debug message file should have been in your USB disk. Please turn the file "dbgms.tar" to the technician.

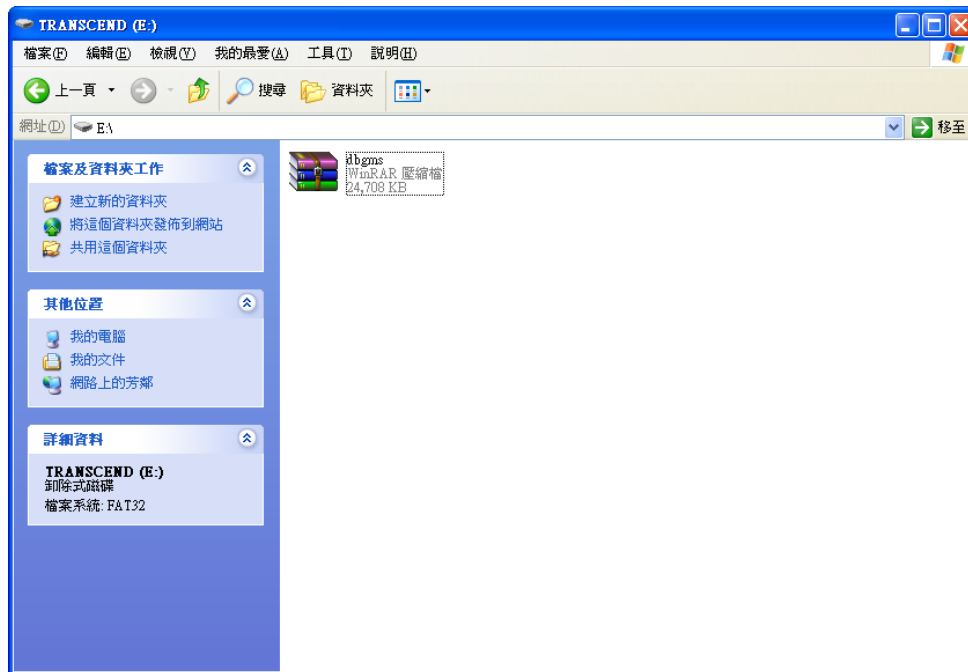

4 NVR PLAYBACK

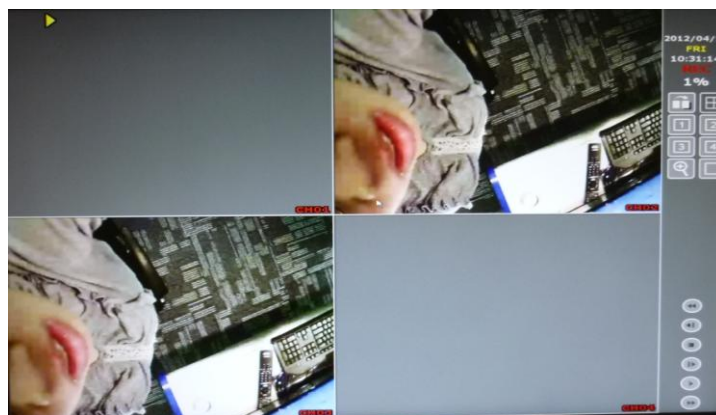

Note: Under playback mode, the sound output is only enabled on full screen mode.

A. RECORD BACKUP

On playback mode, press this button to backup recording (.ha0 video) to the USB disk .Press this button again to finish the backup. To perform a single image backup (.jpg single image backup), press  first and then click the “Record Backup” button to back up the necessary image.

B.  AUDIO VOLUME

Press this button for the audio volume control board to pop up.

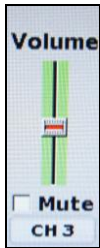

C.  DISPLAY CONTROL

Within playback mode, use the display control to switch the camera channel.

D.  DIGITAL ZOOM

On live full screen mode, left-click the button of the mouse to pull a range to zoom in or zoom out the image. The users can right-click to disable this function. (NOTE: By using the mouse to operate digital zoom, the image can zoom-in to max. 16x.)

E.  FULLSCREEN

Press the bottom for full-screen mode.

F.  RECORD AND PLAYBACK CONTROL

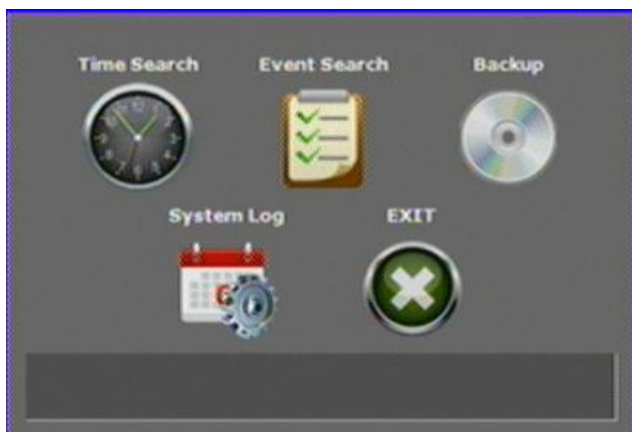



4.1 TIME SEARCH

Select the start of the playback time and then click the **Start Play** button to playback the recorded data. If a period of time contains the recorded data, the time point within this page will become red.

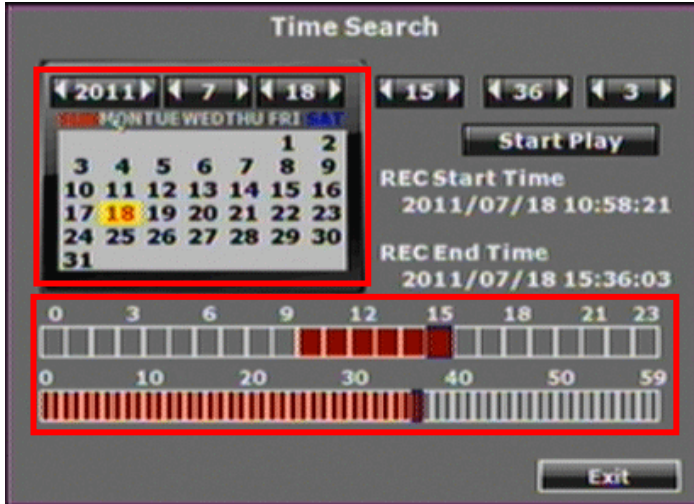

4.2 EVENT SEARCH

After entry to the event search page, the user can click the event log item which is shown on the list for starting playback. Moreover, the user could click the **Event Filter** button to select the specific event option to filter the event option shown on the list.

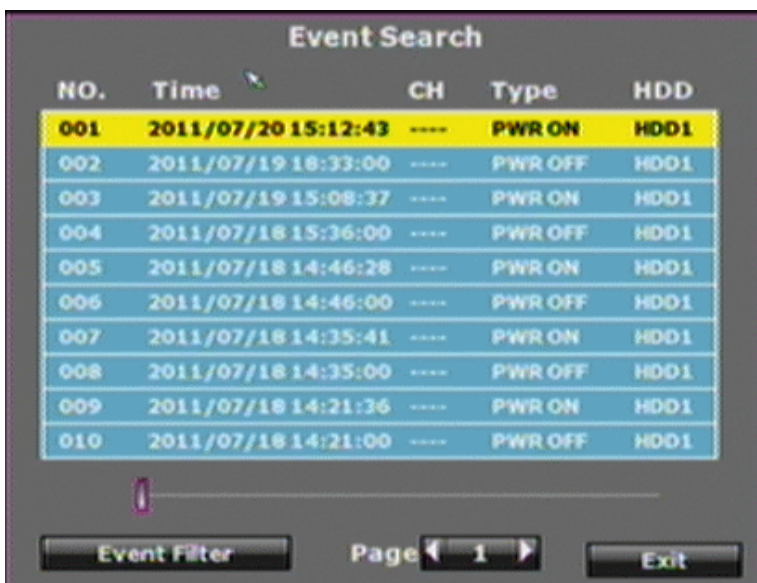



4.3 BACKUP

After clicking the backup button, the user could use the drop down list to select the storage device, the backup time selection mode and time. Please click the **Backup Now** button to start backup.

TIME MODE

Click ◀ or ▶ to select the start and end backup time. Moreover, click the **Select Channel** button to select the channel which is going to backup.

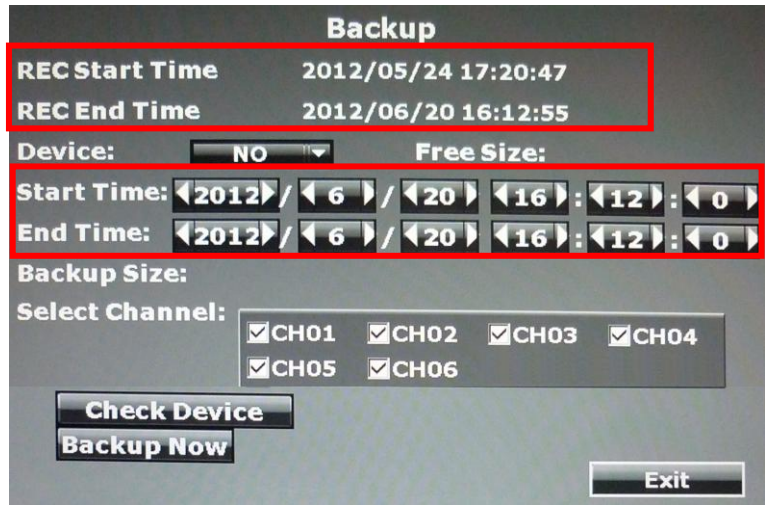

4.4



SYSTEM LOG

The system log holds all of the system records. The maximum quantity of records is 2000. Click the **Log Filter** button to perform further data filter actions. After completing the specific item selection, click the **Save** button to save the settings. When returning to the system log page, it will only reveal the specific selected items.

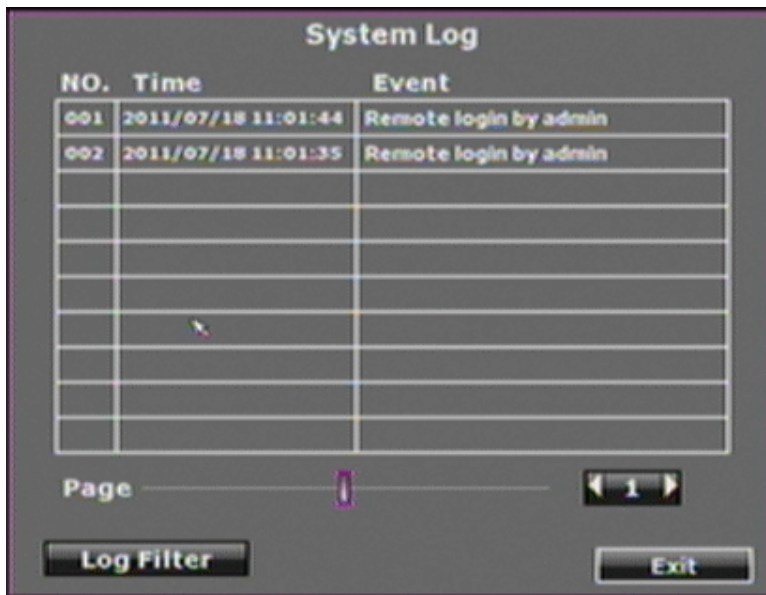

After click **Log Filter** button



After finishing the backup, use D6Viewer to open the log file.



Time	Event
2013/10/15_09:55:51	Remote login by admin
2013/10/11_09:27:46	Remote login by admin
2013/10/11_09:27:43	Remote login by admin
2013/10/09_09:10:51	Remote login by admin
2013/10/09_09:10:38	Remote login by admin
2013/10/08_09:06:36	Remote login by admin
2013/10/08_08:58:46	Remote login by admin
2013/10/08_08:58:42	Remote login by admin
2013/10/07_09:30:23	Remote login by admin
2013/10/07_09:30:21	Remote login by admin

5 BACKUP PLAYBACK

SYSTEM REQUIREMENT

CPU: Intel Celeron 1.6G

MEMORY: 256MB.

VGA: 32MB

VGA RESOLUTION: 1024 x 768.

OS: Windows XP / 2000 or above

SUGGESTED REQUIREMENT

CPU: Intel P4 2.8G

MEMORY:512MB or above

VGA:64MB or above

VGA RESOLUTION:1024 x 768

OS: Windows XP / 2000 or above

NETWORK BANDWIDTH: Upload Speed is 256kbps or above

5.1 MAIN SCREEN SETTING



The player (D6Viewer.exe) is used to play the NVR backup video. D6Viewer.exe can be obtained via the Internet; moreover, while performing USB backup and DVD-RW backup, the software will be built automatically as well.

A. MAIN SCREEN

Open the D6Viewer. Use Overlay mode can improve the system resource performance.

The screenshot shows the D6Viewer application window. The main area displays a grid of video channels (Ch. 1 to Ch. 36) with their respective timecodes. The interface includes a menu bar (File, About), a playback control panel on the right, and a search panel at the bottom right. Red boxes and arrows highlight specific features:

- File Menu:** A red box highlights the 'File' menu, with an arrow pointing to the 'HDD Play' option. A label 'Select video source' points to this menu.
- Playback Control:** A red box highlights the playback controls (play, stop, previous, next), with a label 'Playback Control' pointing to the top right.
- Channel Selection:** A red box highlights the 'Backup' dropdown menu, with an arrow pointing to 'CH.1'. A label 'Channel Selected' points to this dropdown.
- Save as AVI:** A red box highlights the 'Save AVI' button, with a label 'Save as AVI' pointing to it.
- Search:** A red box highlights the search fields (Date: 2012/10/17, Time: 16:24:04), with a label 'Time & Event Search' pointing to them.
- Channel Division Screen:** A red box highlights the numeric keypad (1-9, 16, 25, 36), with a label 'Channel Division Screen' pointing to it.

B. HDD PLAY

1. Remove the NVR HDD and connect it to the PC. The NVR HDD uses a Linux format, so the Windows system may not read it. Please use the software “Ext2Fsd” to assign a drive letter to the HDD. “Ext2Fsd” is in the attached CD or can be downloaded from the Internet.
- Start the Ext2Fsd, and it will detect all the disks connected with your PC. Right-click on the NVR HDD and choose “Change Drive Letter”.

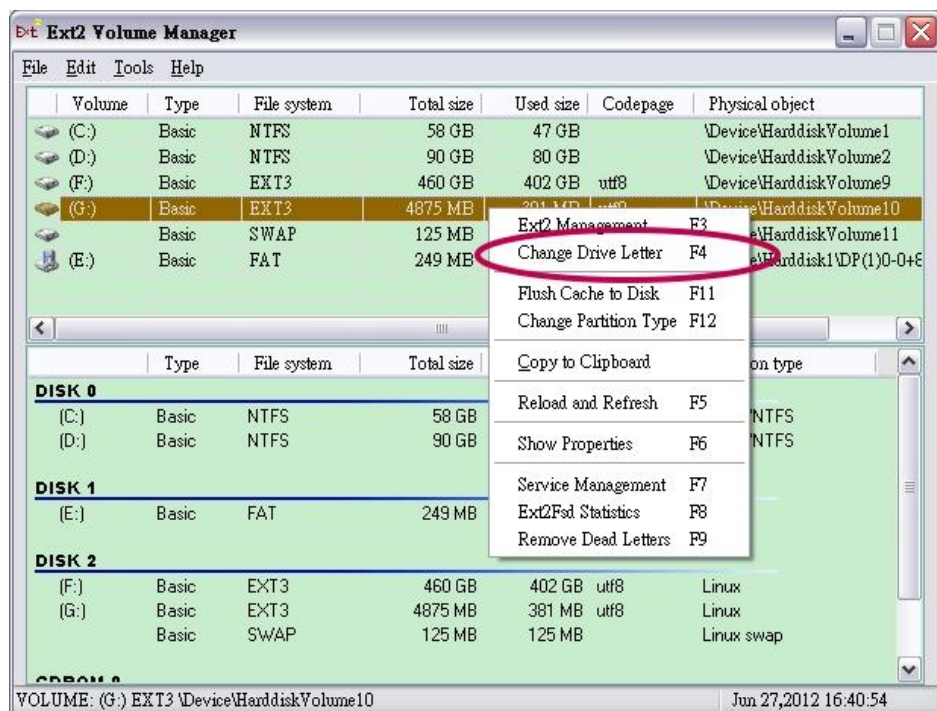

- Click “Add”

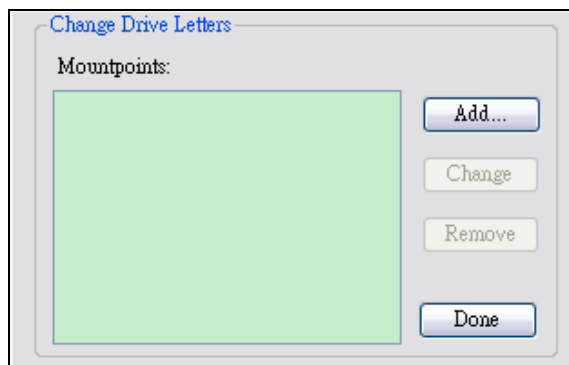

- Assign a letter to the HDD, then click “OK” so that the HDD get a drive letter and can be recognized by Windows.

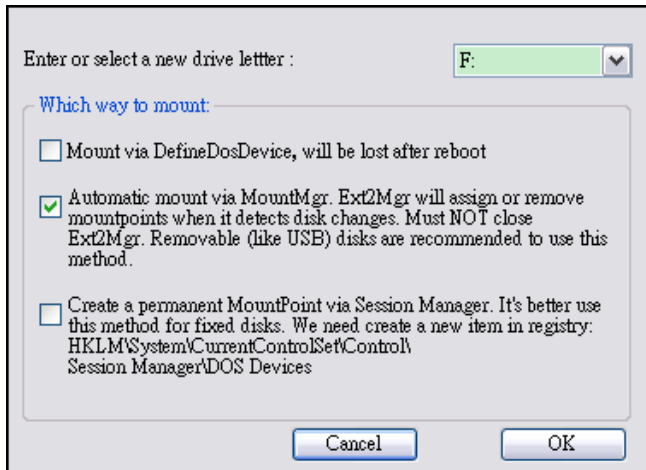

2. Under HDD play mode, select the NVR HDD to load the video file in the HDD.

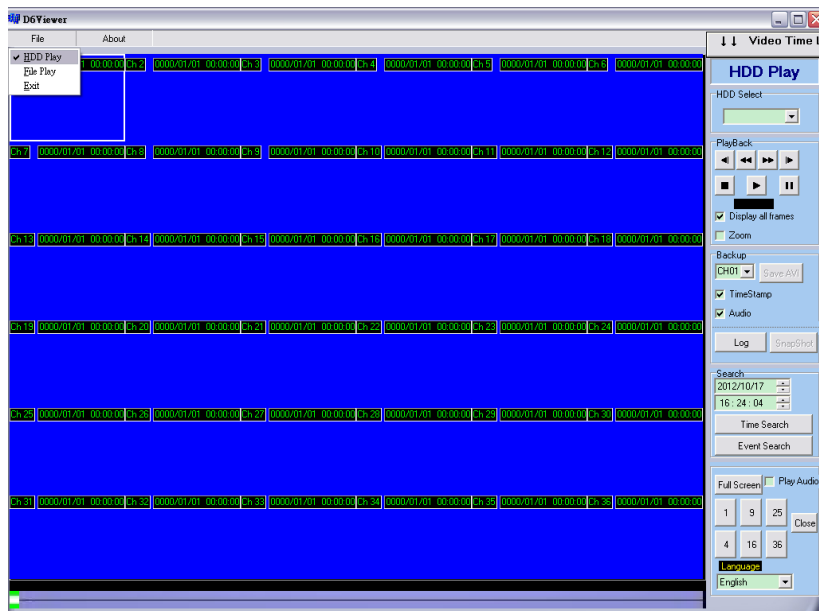

C. File Play

1. You can use D6Viewer to open a single video backup file. Under file play mode, select "Open".

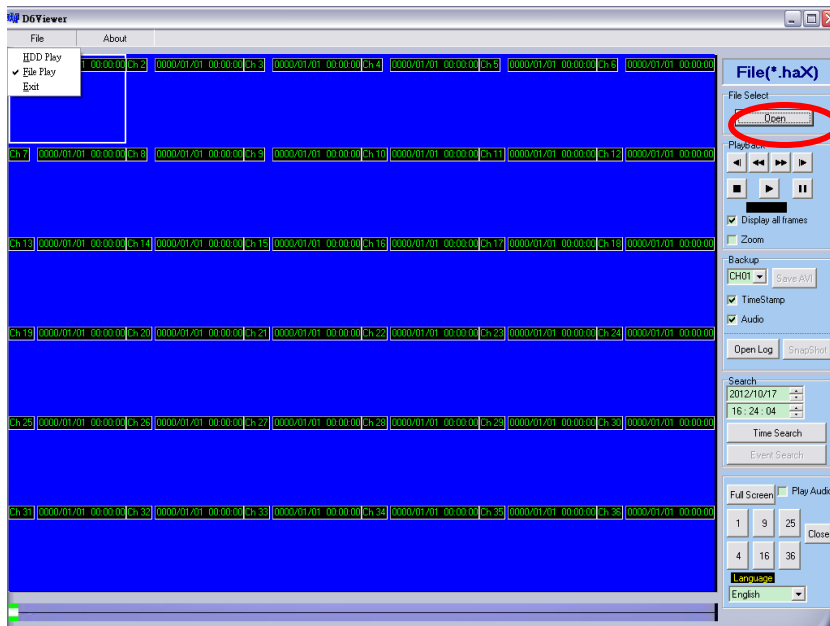

2. Choose the path the .haX file reserved and pick the file to playback.

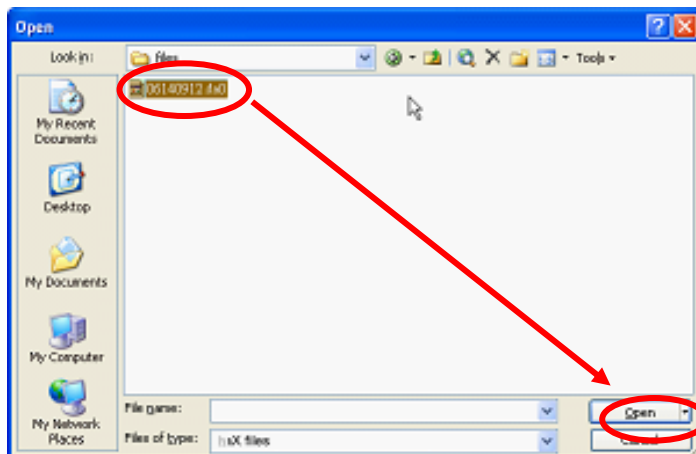

3. Press the play icon to play the video or pause picture.

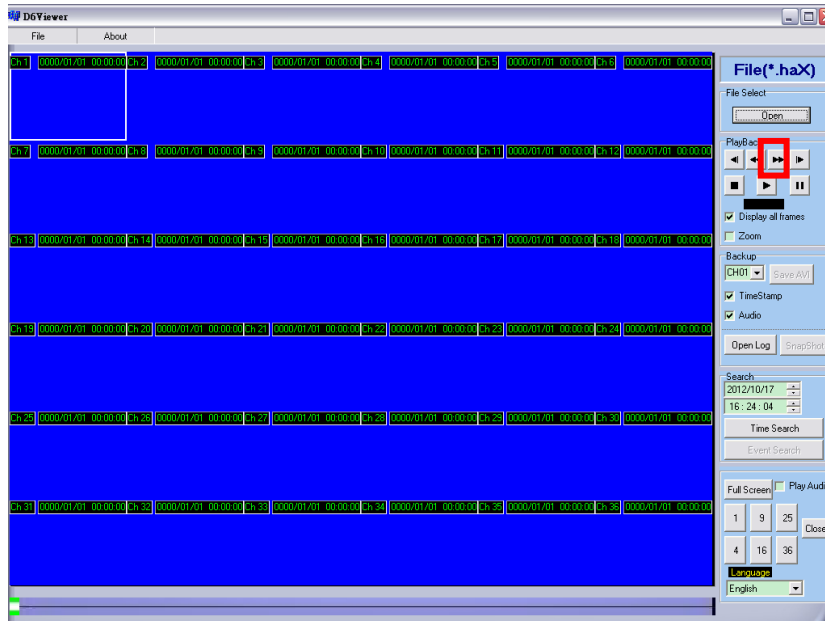

5.2 PLAYBACK OPERATION

A. TIME SEARCH

Select the Date and Time and then click  to play the video.

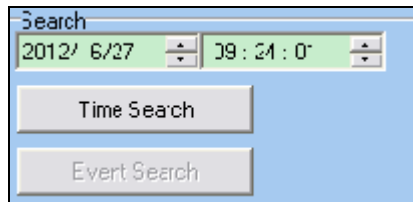

B. EVENT SEARCH

After pressing the  button, it will display all the events which are saved within the NVR HDD (Shown in the following image).

Num	Channel	Time	Type
1	255	2008/02/25_09:53:29	POWER ON
2	255	2008/02/25_09:53:38	POWER ON
3	255	2008/02/25_09:54:56	POWER ON
4	255	2008/02/25_09:56:09	POWER ON
5	255	2008/02/25_09:58:05	POWER ON
6	255	2008/02/25_10:02:45	POWER ON
7	255	2008/02/25_10:13:05	POWER ON
8	255	2008/02/25_10:15:33	POWER ON
9	255	2008/02/25_10:35:06	POWER ON
10	255	2008/02/25_10:37:42	POWER ON
11	255	2008/02/25_10:47:21	POWER ON
12	255	2008/02/25_10:49:25	POWER ON
13	255	2008/02/25_10:51:11	POWER ON
14	255	2008/02/25_10:54:16	POWER ON
15	255	2008/02/25_10:58:08	POWER ON
16	255	2008/02/25_11:00:02	POWER ON
17	255	2008/02/25_11:04:15	POWER ON
18	255	2008/02/25_11:05:35	POWER ON
19	255	2008/02/26_10:28:44	POWER ON

C. LOG

Click to check the log records.

No.	Time	Event
1	2012/05/31_14:31:28	Remote login by admin
2	2012/05/31_14:31:25	Remote login by admin
3	2012/05/31_14:25:25	Remote login by admin
4	2012/05/31_14:25:21	Remote login by admin
5	2012/05/31_14:20:36	Remote login by admin
6	2012/05/31_14:19:32	Remote login by admin

D. ZOOM

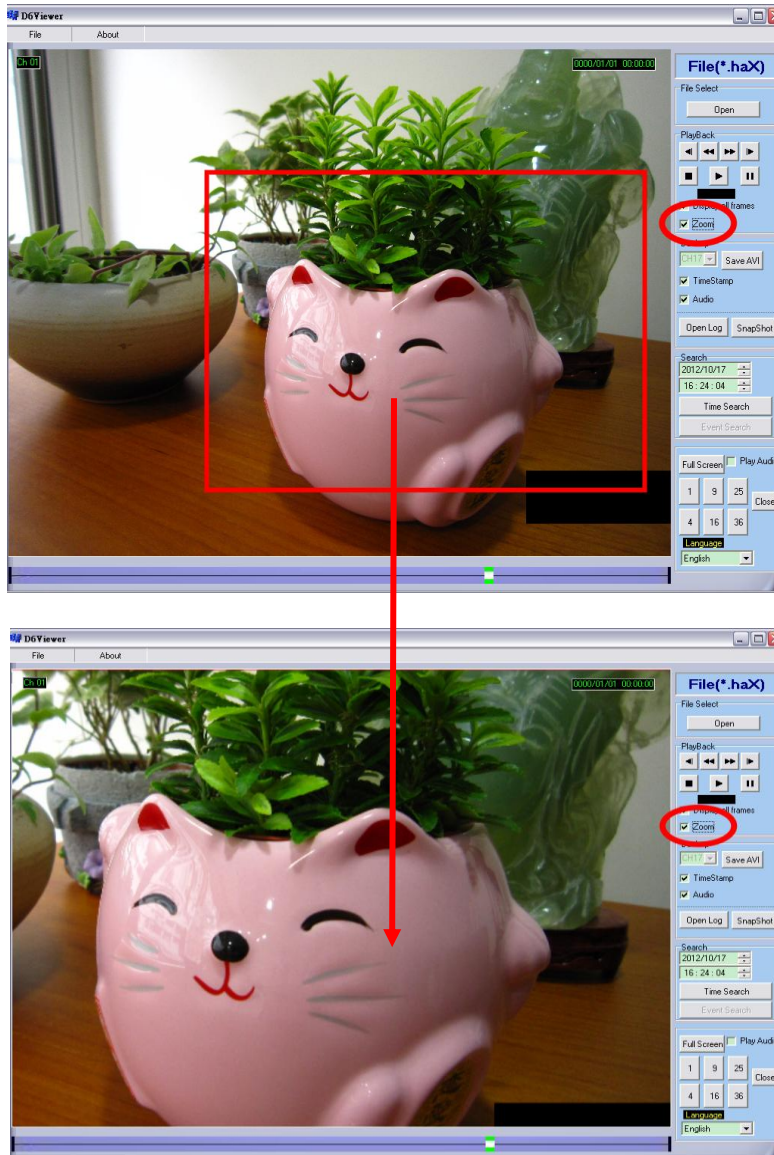

Tick the “Zoom” box and drag an area on the screen. Click the area to zoom in.

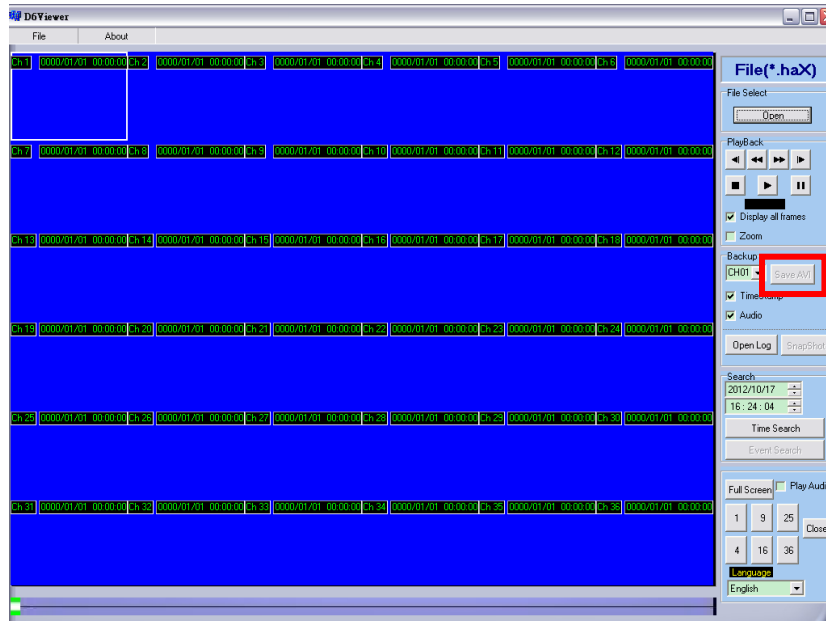

E. BACKUP FILE TO AVI

1. Select the specific channel to backup.

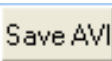

2. During video playback mode please press the  button to start.
3. Make up a filename and path than press the  button to start the AVI backup.
4. Press the  button to finish the backup.

6 NETWORK VIEWING & PLAYBACK

SYSTEM REQUIREMENT

CPU: Intel Celeron 1.6G

MEMORY: 256MB.

VGA: 32MB

VGA RESOLUTION: 1024 x 768.

OS: Windows XP / 2000

SUGGESTED REQUIREMENT

CPU: Intel P4 2.8G

MEMORY: 512MB or above

VGA: 64MB or above

VGA RESOLUTION: 1024 x 768

OS: Windows XP / 2000

NETWORK BANDWIDTH: Upload Speed is 256kbps or above

6.1 IP ADDRESS SETUP ON PC SITE

When installing cameras inside the LAN or using a network cable to connect them to PC, IPInstallerEng.exe will set up the IP address of those cameras. On Windows XP SP2 or above, the following Windows Security Alert will popup. Please click on **Unblock**.



Then, the IPInstallerEng.exe will popup. The NVR default IP address is 192.168.1.220

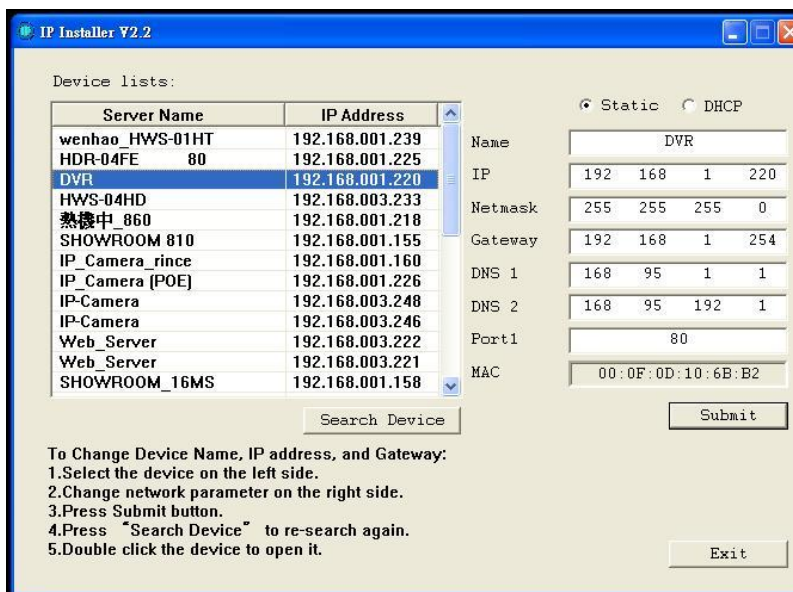

NOTE: Please input correct network parameters without blank spaces.

On “Device Lists”, the software lists all servers. By clicking on the server the IP settings will be show on the right side. After editing the parameters and clicking on “Submit”, the following dialogue box will popup. Then, it will reboot the device with the new parameters.

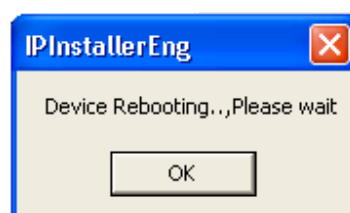

6.2 OPTIONAL MICROSOFT INTERNET EXPLORER SETUP

OPTION 1: DISABLE ACTIVEX WARNING

- A. IE → Tools → Internet Options → Security → Custom Level → Security Settings → Download unsigned ActiveX controls → Enable or Prompt (recommend).
- B. IE → Tools → Internet Options → Security → Custom Level → Security Settings → Initialize and script ActiveX controls not marked as safe → Enable or Prompt (recommend).

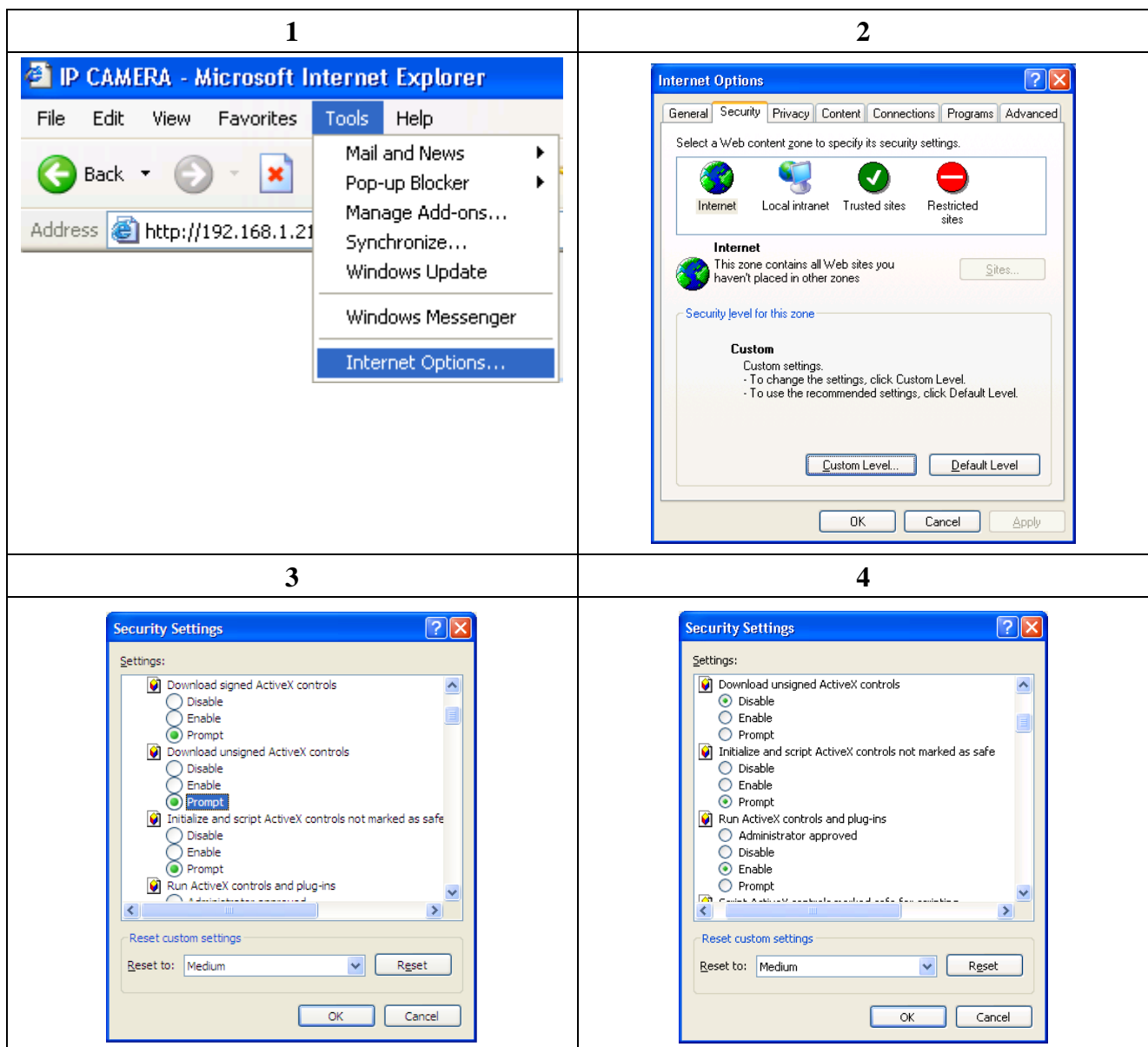

All the three options above are all based on the prompted interfaces.

Please click "YES."

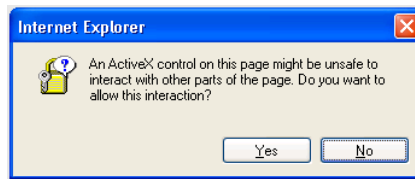

OPTION 2: ADD TO TRUSTED SITES

IE → Tools → Internet Options → Security → Trusted sites → Sites

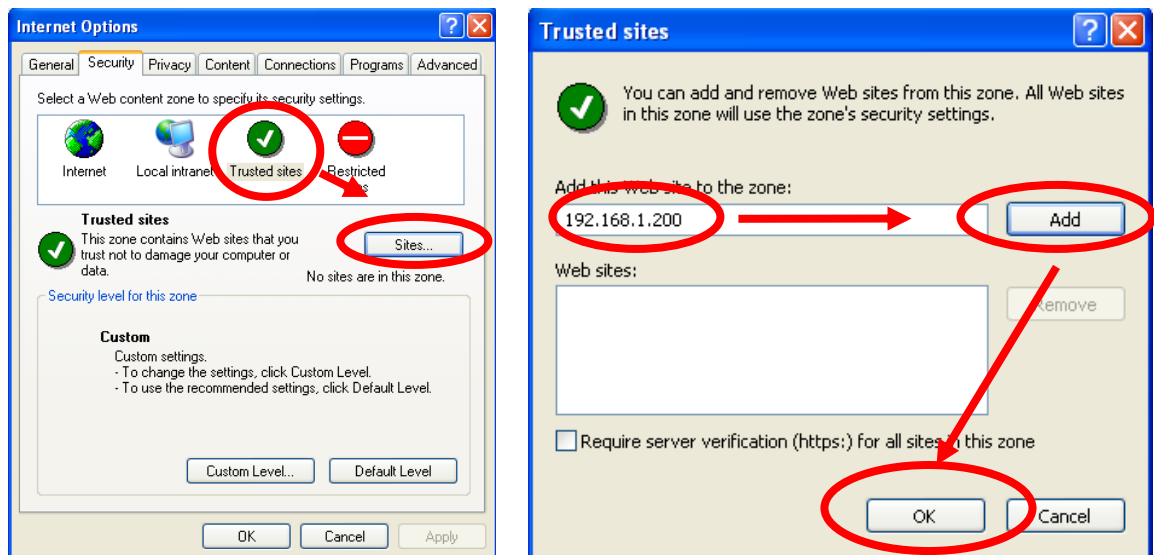

6.3 LOGIN

A. INSTALL ACTIVEX

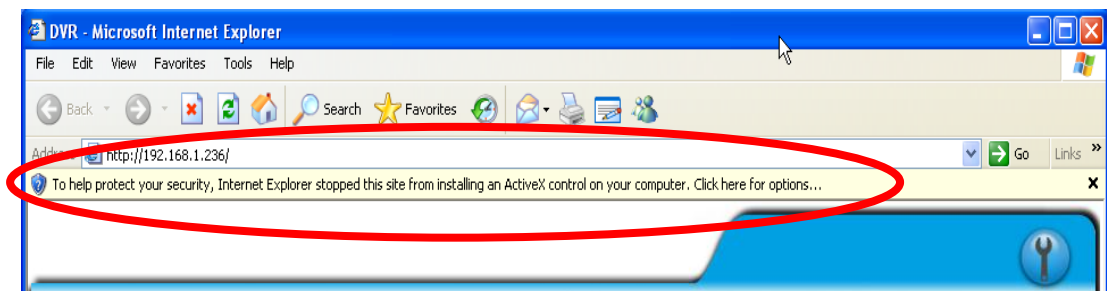

B. START INSTALL ACTIVEX

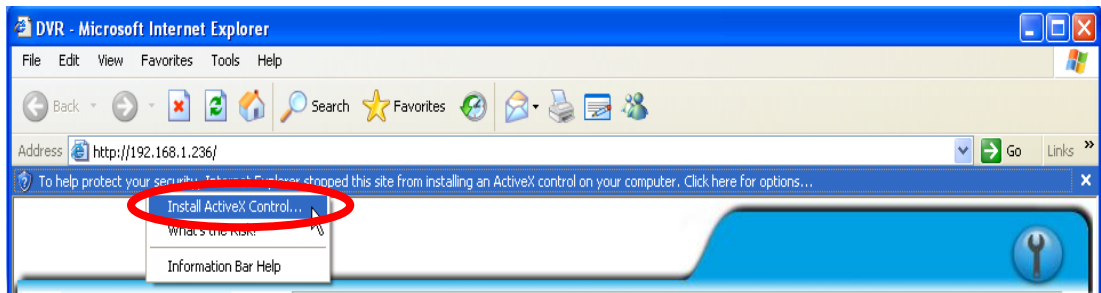

C. ACCOUNT & PASSWORD LOGIN

After the IP setup and connecting to the network or LAN; type directly the IP address on the IE Browser directly. The following User name & Password Login window will popup.

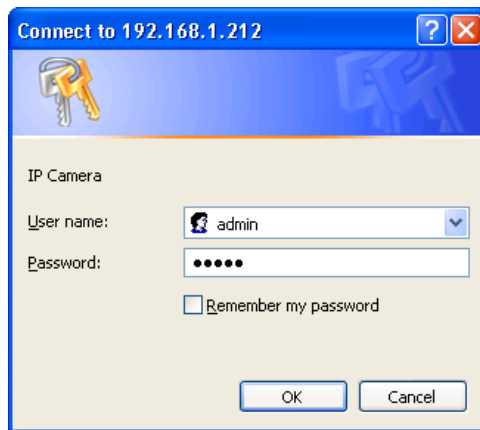

Default user name: admin

Default password: admin

6.4 REMOTE CONTROL

LIVE VIEWING

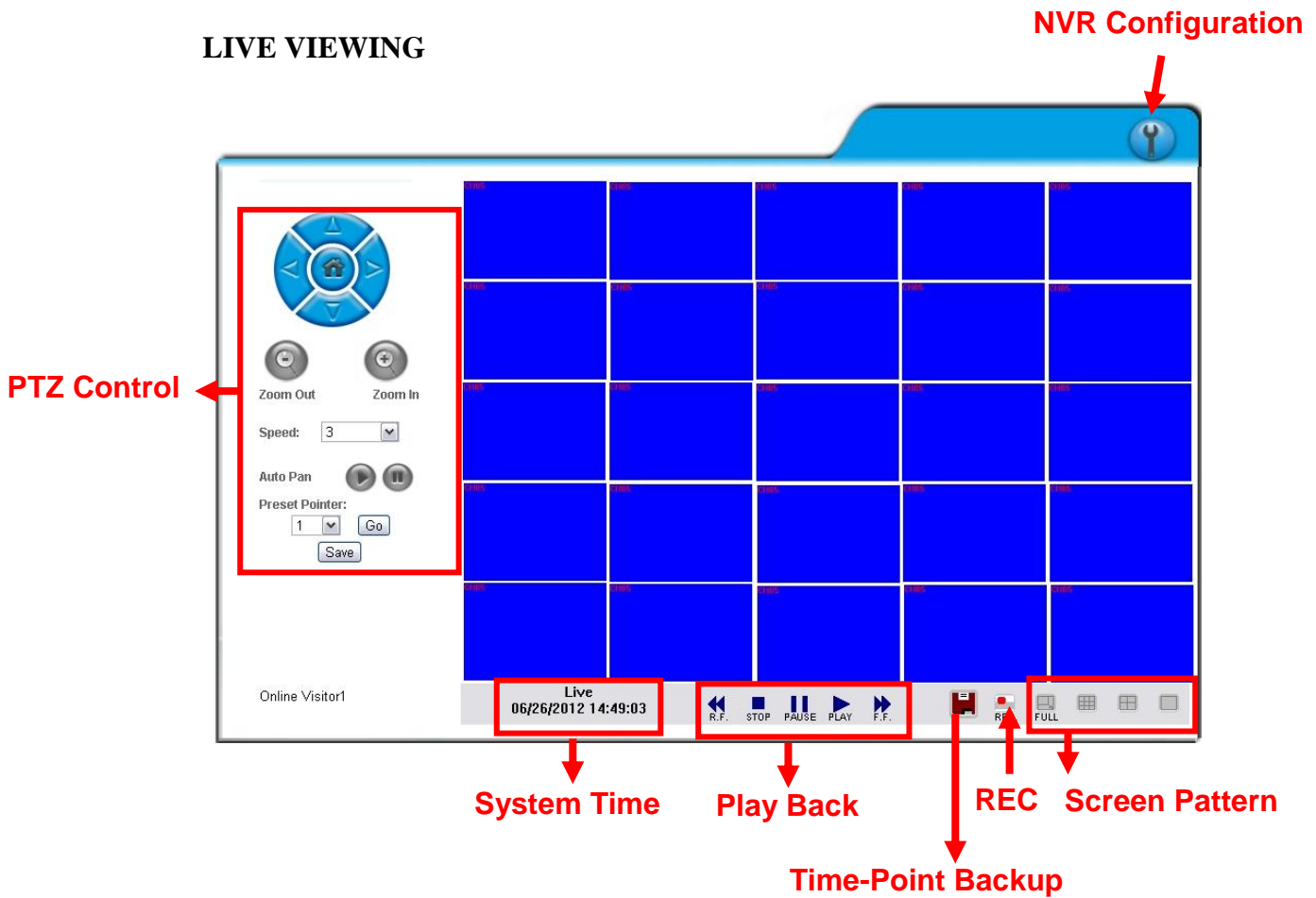

A. NVR Configuration

Get into the NVR network menu.

B. PTZ Control

PTZ control function panel

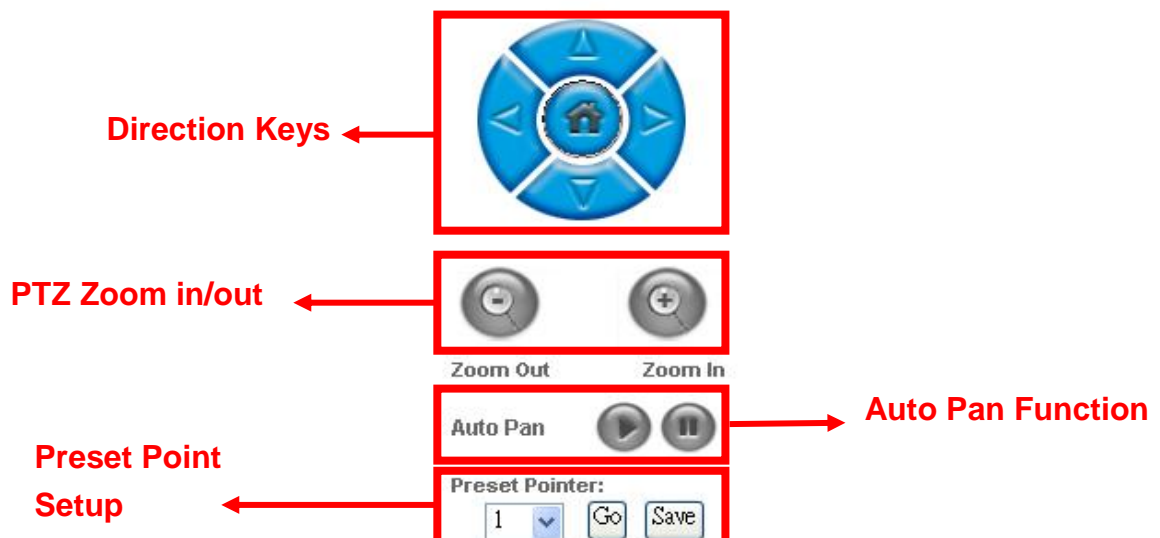

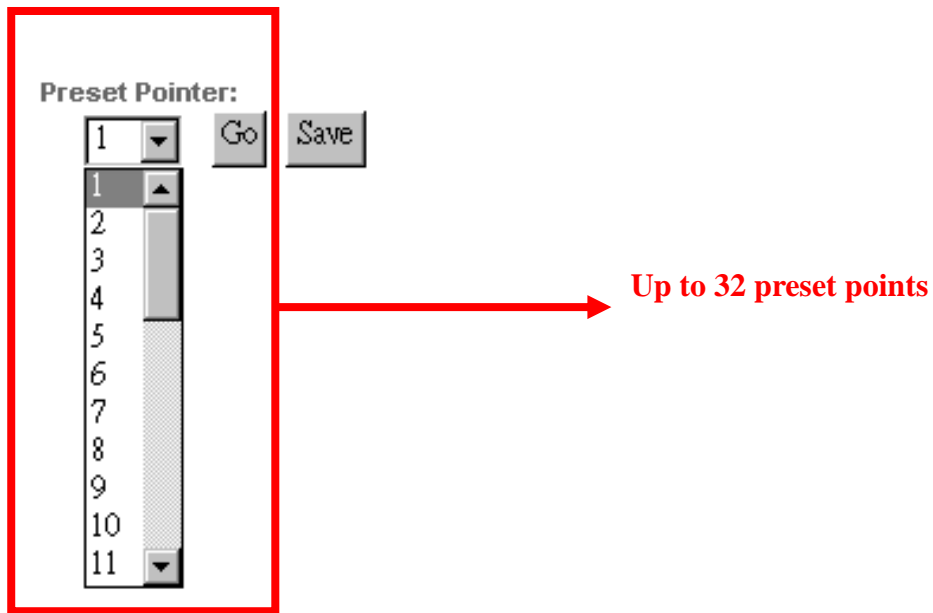

C. SYSTEM TIME

Live viewing mode: The current live viewing time.

D. SCREEN FORMAT

Switch screen format and click twice to switch different channels with full screen.

E. Full Screen.

Click again to return.

F. REC.

Click to start record the live video to the PC or storage device. The saved file is *.ha0 file.

G. Playback

Click and select time playback or event playback.

D. Event Search

The user can select the event item by pressing “Event Search” for playback.

TIME-POINT BACKUP

Click  to operate the Time-Point backup.

First, select the Start and End backup time.

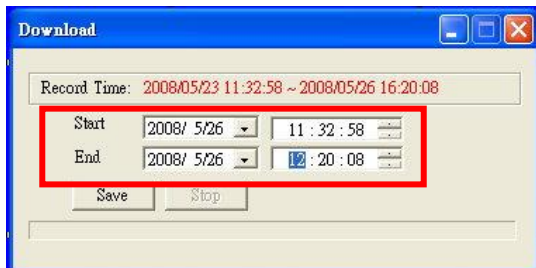

Then, click the **Save** button to select the path on the PC where the user is going to backup the data. After that, press the **OK** button to start the backup.

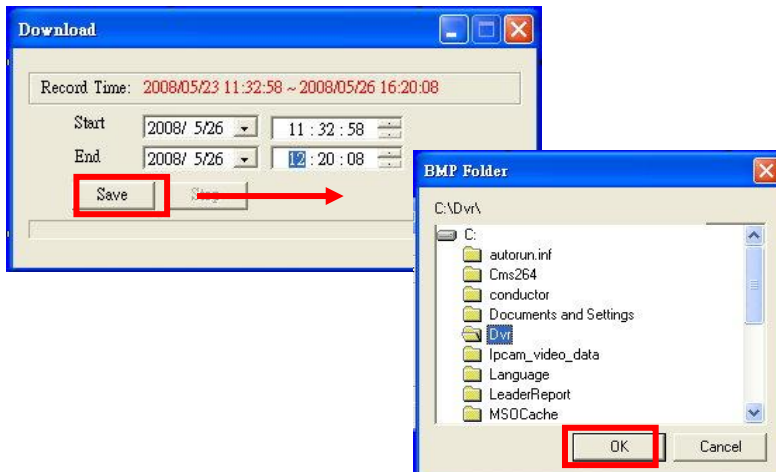

Finally, double-click to open the saved backup file. The backup file will named as the time when started to backup, such as, (20080526113258.ha0) will be 2008/05/26 11:32:58.

OTHER FUNCTIONS

Right-click on any channel. The following menu will pop up:



A. Snapshot:

Save a single picture from the image.

B. Performance:

Select image quality (high, medium & low).

C. Use Overlay:

Save system resources and improve efficacy.

D. Play audio:

Play audio off the channel.

Note: a remote user can receive audio from the NVR. The playback performance is not influenced if the sound is being recorded.

6.5 CONFIGURATION

A. System - System Information

System Information	
Server Information	
Server Name:	NVR
MAC Address:	00:0f:0d:00:12:00
NTP Setting	
Time zone:	GMT-12:00
NTP Server:	198.123.30.132
<input type="button" value="Apply"/>	

A-1 SYSTEM INFORMATION

SERVER NAME: This name will be shown on the IP Installer.

MAC ADDRESS: The MAC address. (It cannot be changed)

A-2 NTP Setting

TIME ZONE: It can only be modified via adjust “DATE” and “TIME SETUP “in the NVR Menu).

NTP SERVER: Change the time of the NVR via NTP Server.

B. SYSTEM – USER MANAGEMENT

User Management			
Authority Setting			
HDD Format Password Check	<input type="radio"/> Enable	<input checked="" type="radio"/> Disable	
Anonymous Login	<input type="radio"/> Enable	<input checked="" type="radio"/> Disable	
Password Protection	<input type="radio"/> Enable	<input checked="" type="radio"/> Disable	<input type="button" value="Apply"/>
User List			
Username	Modify	Remove	<input type="button" value="Add User"/>
admin	Edit		

The User Management provides 3 levels of authority: Administrator (the highest), User, and Guest.

Administrator: Posses the highest level of authority to operate full functions within network.

User: Live Image and Video Playback authority. Moreover, PTZ controlled is included as well.

Guest: Live Image authority only.

Default administrator account: Username: admin Password: admin

B-1 AUTHORITY SETTING:

Enable or Disable these options to limit the authority.

B-2 USER MANAGEMENT:

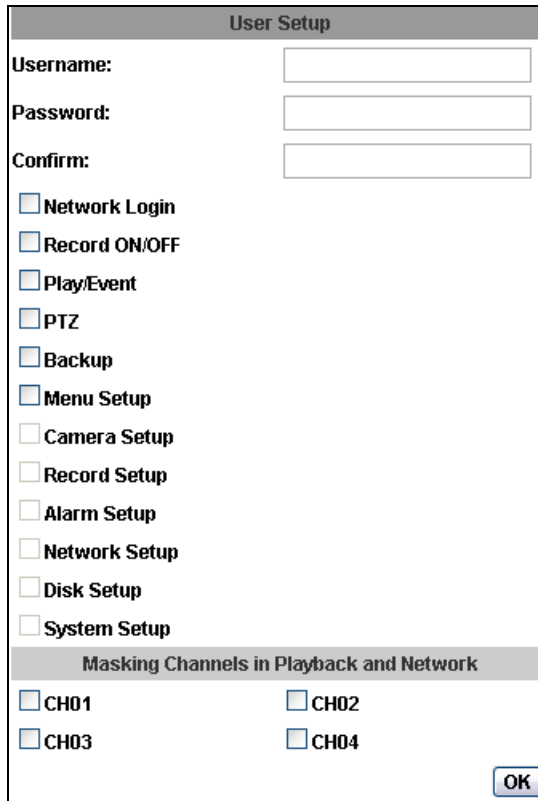

The image shows a 'User Setup' dialog box with the following fields and options:

- Username: [Text Input]
- Password: [Text Input]
- Confirm: [Text Input]
- Network Login
- Record ON/OFF
- Play/Event
- PTZ
- Backup
- Menu Setup
- Camera Setup
- Record Setup
- Alarm Setup
- Network Setup
- Disk Setup
- System Setup

Below these options is a section titled 'Masking Channels in Playback and Network' with four checkboxes:

- CH01
- CH02
- CH03
- CH04

An 'OK' button is located at the bottom right of the dialog box.

Add: Key-in the Username and Password. The manager can give authority to the new user by ticking at the choice below. (Ex. Ticking at “PTZ” allows the new user to control the PTZ functions). You can apply the authority settings to the channel you choose. The new user has no authority in those channels that are not selected.

Modify: Click **Edit** for the following window to pop-up. After typing the Password and confirming it, click on **OK**. You can also change the masking channel here.

Remove: Click on the user name on the user list and click on **Remove**.

C. SYSTEM / SYSTEM UPDATE

System Update	
Firmware Upgrade	
Firmware Version:	V1.0.25 M0323
New Firmware:	<input type="button" value="選擇檔案"/> 未選擇檔案
	<input type="button" value="Upgrade"/>
Load Default	
Load Setup From Default	<input type="button" value="Apply"/>
Load Setup From:	<input type="button" value="選擇檔案"/> 未選擇檔案
	<input type="button" value="Apply"/>
Backup Setup	<input type="button" value="Download"/>

Firmware Upgrade:

Click on the “Browse” button to select the latest firmware and then press the “Upgrade” button to upgrade the firmware.

Load Default:

Click “Browse” to choose a file. You can load the setup from your computer if you clicked on “Download” and saved the settings before.

ActiveX Updating:

The ActiveX control should be also updated when you update the DVR/NVR firmware. Use the tool in the attached CD to uninstall the old ActiveX control so that the newest version can be registered.

- Automatic Uninstall

Please follow the steps:

1. After updating the DVR/NVR firmware, close the web browser.
2. Run the "unreg" file in the CD to automatically remove the existing ActiveX component "WATCH_16R" from your PC.
3. Log in the DVR/NVR via web browser again, and the browser will require you to install the new version of ActiveX control.

- Manual Uninstall

If the tool does not work, please follow the following steps to uninstall the ActiveX control manually.

1. Look for the files "KConfig.ocx" and "WATCH_16R.ocx" in one of the possible paths:

"C:\WINDOWS\Downloaded Program Files"

"C:\WINDOWS\W16R"

"C:\WINDOWS\system32\WATCH_16R"

2. "Start" -> "Run" -> Key-in: regsvr32(The path of KConfig.ocx) /u -> Click "OK"

Ex.: regsvr32 C:\WINDOWS\system32\WATCH_16R\KConfig.ocx /u



3. "Start" -> "Run" -> Key-in: regsvr32(The path of WATCH_16R.ocx) /u -> Click "OK"

Ex.: regsvr32 C:\WINDOWS\system32\WATCH_16R\WATCH_16R.ocx /u



4. Log-in again into the DVR/NVR via web browser. The browser will ask you to install the new version of ActiveX control.

D. NETWORK – IP SETTING

IP Setting	
IP Assignment	
<input type="radio"/> DHCP	
<input checked="" type="radio"/> Static	
IP Address:	192.168.1.211
Subnet Mask:	255.255.255.0
Gateway:	192.168.1.254
DNS 1:	168.95.1.1
DNS 2:	168.95.192.1
Web Page Port:	80
UPNP Port Forwarding	
<input type="checkbox"/> Enabled	
External HTTP Port:	80
External RTSP Port:	554
<input type="button" value="Apply"/>	

D-1 IP ASSIGNMENT

DHCP: In Dynamic Host Configuration Protocol (DHCP) mode, the DHCP server setting is done automatically.

STATIC IP: Input the IP address, Subnet Mask, and Gateway based on the network environment.

D-2 UPNP PORT FORWARDING

When a router is used, you can enable this function to allow the user to link the device in the intranet.

E. NETWORK – PPPoE

PPPoE Setting

Enabled Disabled

Username:

Password:

Send mail after dialed

Enabled

Subject:

Apply

E-1 PPPoE SETTING

Click on Enabled to enable the ADSL dial function.

Username: Username for ADSL account.

Password: Password for ADSL account.

After dialed successfully, new IP address will appear.

E-2 SEND MAIL AFTER DIALED

Click on Enabled to enable the SEND MAIL AFTER DIALED function. You can also give a subject for the mail.

F. NETWORK / DDNS SETTING

DDNS Setting

Enabled Disabled

Provider:

Hostname:

Username:

Password:

Schedule Update: Minutes

State

Apply

Note:

1. Schedule Update: Feature of DDNS schedule update is designed for IP products which installed behind the ICS or NAT devices. Update range from every 5 (minutes) to 5000 (minutes) and 0 remain to off.
2. Please note that the hostname will be blocked by DynDNS.org if schedule update is more than once every 5 minutes to 60 minutes. In general, schedule update in every 1440 minutes is recommended.

Click on Enabled to enable the DDNS function.

F-1 DYNDNS.ORG

The screenshot shows a web interface titled "DDNS". Under the "DDNS Setting" section, there are two radio buttons: "Enabled" (which is selected) and "Disabled". Below this, there is a "Provider:" dropdown menu currently showing "dyndns.org". There are four text input fields for "Hostname:", "Username:", "Password:", and "Schedule Update:". The "Schedule Update:" field contains the number "0" and is followed by the text "Minutes". At the bottom of the form is a "State" section with a large empty text area and a vertical scrollbar on the right. An "Apply" button is located at the bottom right of the form.

DDNS SETTING - DYNDNS.ORG

PROVIDER: Select dyndns.org

HOSTNAME: The registered hostname in DYNDNS.ORG.

USERNAME: The registered username in DYNDNS.ORG.

PASSWORD: The registered password in DYNDNS.ORG.

SCHEDULE UPDATE: A period of time to update IP address.

STATE

1. Updating: Information update.
2. Idle: Stop service.
3. DDNS registered successfully, now log by
`http://<username>.ddns.camddns.com: Registered successfully.`
4. Updating Failed, the name is already registered.
5. Updating Failed, please check your internet connection.

F-2 DDNS.CAMNND.S.COM

DDNS

DDNS Setting

Enabled Disabled

Provider: ddns.camddns.com

Username:

Schedule Update: 5 Minutes

State

Idle

Apply

Schedule Update: Feature of DDNS schedule update is designed for IP products which installed behind the ICS or NAT devices. Update range from every 5 (minutes) to 5000 (minutes) and 0 remain to off.

DDNS SETTING – DDNS.CAMDDNS.COM

PROVIDER: Select the ddns.camddns.com

USERNAME: Type-in the registered username in DDNS.CAMDDNS.COM.

SCHEDULE UPDATE: The period of time to update IP address.

STATE

1. Updating: Information update.
2. Idle: Stop service.
3. DDNS registered successfully, now log by
`http://<username>.ddns.camddns.com`: Registered successfully.
4. Updating Failed, the name is already registered.
5. Updating Failed, please check your internet connection.

DDNS Setting Steps:

Tick “ENABLE” to enable the DDNS function and select “**ddns.camddns.com**” of the provider from the drop down list. In the following, type the username to apply (e.g. **NVR_GODDNS**). After that, click on the “Apply” button.

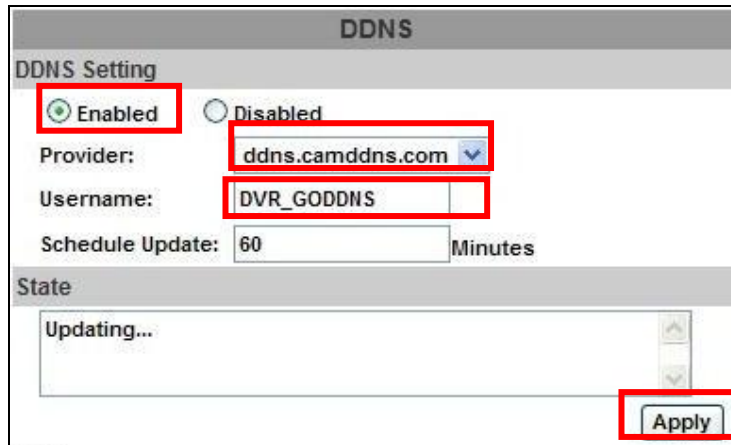

The screenshot shows the 'DDNS' configuration window. Under 'DDNS Setting', the 'Enabled' radio button is selected. The 'Provider' dropdown menu is set to 'ddns.camddns.com'. The 'Username' field contains 'DVR_GODDNS'. The 'Schedule Update' is set to '60' minutes. The 'State' block shows 'Updating...'. The 'Apply' button is highlighted with a red box.

Finally, the NVR domain name (**http://NVR_GODDNS.ddns.camddns.com**) will be shown on the state block.



The screenshot shows the 'DDNS' configuration window after the settings have been applied. The 'State' block now displays the full domain name: 'http://DVR_GODDNS.ddns.camddns.com'. The 'Apply' button is still visible at the bottom right.

- NOTES:**
1. If the user selects another provider as is ddns2.ydsNVR.com, all of the setting steps are the same as ddns.camddns.com setting.
 2. However, if dyndns.org provider is selected, please go to www.dyndns.org to register the account first. The user has to fill-in the username, password and hostname for applying the account. After the user applied the account successfully, the dyndns.org will provide complete DDNS domain name to the user.

3. If setting up the IP schedule update too frequently, the IP may be blocked. In general, scheduling an update every day (1440 minutes) is recommended.

G. NETWORK / Mail & FTP

Click on “Motion” or “Alarm” option to enable Mail Setting and FTP Setting function.

Mail & FTP

Mail Setting: Motion Alarm

Mail Server:

SMTP Port:

Username:

Password:

Sender's Mail:

Receiver's Mail:

Bcc Mail:

Event Subject:

FTP Setting: Motion Alarm

FTP Server:

Username:

Password:

Port:

Path:

Apply

Mail Setting: Tick “Alarm” to send video to the mail address when a external alarm or DI from IP Cam is triggered. Tick “Motion” to send video to the mail address when motion detection is triggered.

Mail Server: The IP address of the Mail Server (e.g. mail.huntelec.com.tw).

SMTP Port: The port of the SMTP (known as Simple Mail Transfer Protocol). (The default value is 25)

Username: The username for logging into the mail server.

Password: The password for logging into the mail server.

Sender's Mail: The sender's account for sending mail via this mail server.

Receiver's Mail: The receiver's mail address.

Bcc Mail: The receiver's mail address for Bcc Mail.

Event Subject: The subject of this mail. (The default value is ALARM MAIL)

FTP Setting: Tick “Alarm” to upload video to FTP when external alarm or DI from IP Cam is triggered. Tick “Motion” to upload video to FTP when motion detection is triggered.

FTP Server: The IP address of FTP Server.

Username: The username for logging into the ftp server.

Password: The password for logging into the ftp server.

Port: The port number for file transmission. (Default value is 21)

Path: The ftp path where for saving the information.

Finally, click on the **Apply** button to save the settings.

H. NETWORK /DHCP Server Setup

Give the IP address to set up the DHCP Server. The IP will change between the Start IP and the End IP.

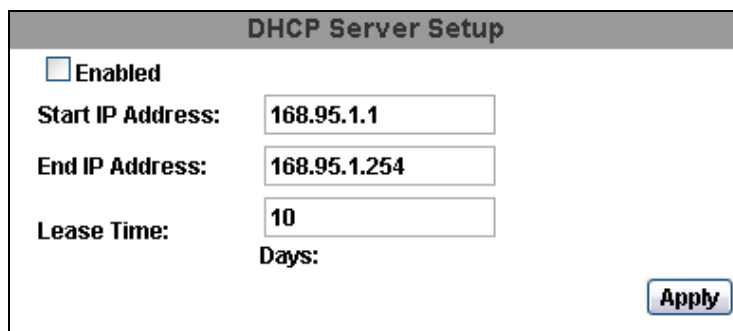

The screenshot shows a window titled "DHCP Server Setup". It contains the following fields and controls:

- An unchecked checkbox labeled "Enabled".
- A "Start IP Address:" field with the value "168.95.1.1".
- An "End IP Address:" field with the value "168.95.1.254".
- A "Lease Time:" field with the value "10".
- A "Days:" label positioned below the Lease Time field.
- An "Apply" button in the bottom right corner.

I. HTTP Notification

Use the checkbox to enable or disable HTTP Notification. This function allows users to set up the CGI command to a HTTP server. The server can be any device that can receive CGI via HTTP protocol. When an alarm event occurs the NVR sends CGI to that server.

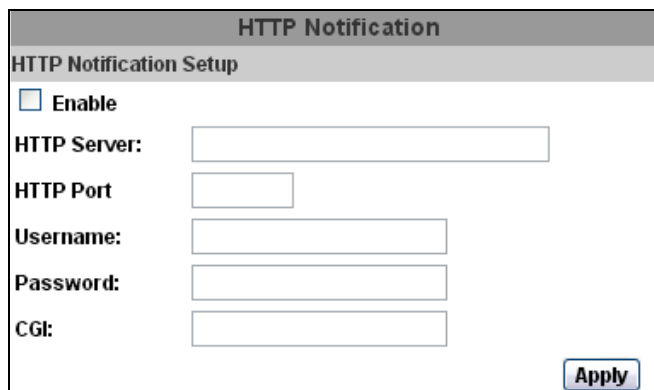

The screenshot shows a window titled "HTTP Notification". It contains the following fields and controls:

- An unchecked checkbox labeled "Enable".
- An "HTTP Server:" field.
- An "HTTP Port" field.
- A "Username:" field.
- A "Password:" field.
- A "CGI:" field.
- An "Apply" button in the bottom right corner.

HTTP Server: Key-in the server IP address.

HTTP Port: Key-in the server port used for http protocol.

User Name: Key-in the server username.

Password: Key-in the server password.

HTTP CGI: Key-in the CGI that you would like to send to the server when an alarm event occurs.

J. OTHERS / Player Downloaded

Click “Player” in the left list, and your browser will start up downloading D6Viewer.exe to your PC.

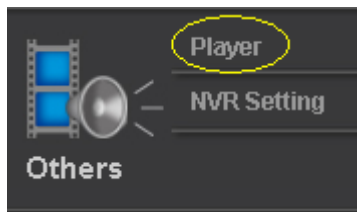

K. OTHERS/ NVR Setting

The NVR settings can be changed via the Internet.



K-1 CAMERA Setting

Please refer to [Chapter3.3-Camera Setup](#).

CAMERA	RECORD	ALARM	DISK	SYSTEM	SAVE
CAMERA	<input type="text" value="1"/>	<input type="button" value="◀"/>	<input type="button" value="▶"/>		
IPCAM SETUP		<input type="button" value="SET"/>			
IPCAM VIDEO SETUP		<input type="button" value="SET"/>			
IPCAM IMAGE SETUP		<input type="button" value="SET"/>			
MOTION		<input type="button" value="SET"/>			
MASK SETUP		<input type="button" value="SET"/>			
IPCAM AUDIO SETUP		<input type="button" value="SET"/>			

K-2 RECORD SETTING

Please refer to [Chapter3.4- Record Setup](#)

CAMERA	RECORD	ALARM	DISK	SYSTEM	SAVE
PRE-ALARM RECORDING TIME	<input type="text" value="10"/>	SEC	<input type="button" value="◀"/>	<input type="button" value="▶"/>	
POST-ALARM RECORDING TIME	<input type="text" value="10"/>	SEC	<input type="button" value="◀"/>	<input type="button" value="▶"/>	
RECORD MODE	<input type="text" value="SCHEDULE"/>		<input type="button" value="◀"/>	<input type="button" value="▶"/>	
SCHEDULE SETUP				<input type="button" value="SET"/>	
RECORD	<input type="text" value="ON"/>			<input type="button" value="START RECORD"/>	
				<input type="button" value="STOP RECORD"/>	

K-3 ALARM SETTING

Please refer to [Chapter3.5-Alarm Setup](#)

CAMERA	RECORD	ALARM	DISK	SYSTEM	SAVE
ALARM TRIGGER SETUP					SET
ALARM OUTPUT SETUP					SET
ALARM EVENT SETUP					SET

K-4 DISK SETTING

Please refer to [Chapter3.8-Disk Setup](#)

CAMERA	RECORD	ALARM	DISK	SYSTEM	SAVE
OVERWRITE MODE	OFF		◀ ▶		
HARD DISK FULL WARNING	15%		◀ ▶		
AUTO DELETION	ON		◀ ▶		
RESERVE DAY	27		◀ ▶		

K-5 SYSTEM SETTING

Please refer to [Chapter3.9-System Setup](#)

CAMERA	RECORD	ALARM	DISK	SYSTEM	SAVE
NVR NAME	NVR-04		SET		
NVR ID	0		◀ ▶		
DATE FORMAT	YYYY-MM-DD		◀ ▶		
Monitor Resolution	1024x768		◀ ▶		
STATUS DISPLAY SETUP					SET
DAYLIGHT SAVING TIME					SET

APPENDIX A: RECORDING TIME LAPSE (HOURS)

2TB					UNIT : Hours
IMAGE QUALITY (Mbps)	LOW(0.25M)	MEDIUM(0.5M)	STANDARD(1M)	HIGH(1.5M)	
	AVERAGE	AVERAGE	AVERAGE	AVERAGE	
16CH	960	480	240	160	
4TB					UNIT : Hours
IMAGE QUALITY (Mbps)	LOW(0.25M)	MEDIUM (0.5M)	STANDARD (1M)	HIGH (1.5M)	
	AVERAGE	AVERAGE	AVERAGE	AVERAGE	
16CH	1920	960	480	320	
6TB					UNIT : Hours
IMAGE QUALITY (Mbps)	LOW(0.25M)	MEDIUM (0.5M)	STANDARD (1M)	HIGH (1.5M)	
	AVERAGE	AVERAGE	AVERAGE	AVERAGE	
16CH	2880	1440	720	480	
8TB					UNIT : Hours
IMAGE QUALITY (Mbps)	LOW(0.25M)	MEDIUM (0.5M)	STANDARD (1M)	HIGH (1.5M)	
	AVERAGE	AVERAGE	AVERAGE	AVERAGE	
16CH	3840	1920	960	640	

* The value is for reference only

APPENDIX B: HDD COMPATIBLE TABLE

Brand	Model	Capacity	Others
SEAGATE	ST3500320SV	500GB	SV35.3
	ST3500410SV	500GB	SV35.5
	ST3500413AS	500GB S3	Barracuda 7200 12
	ST3500418AS	500GB	7200 12
	ST500NM0011	500GB	
	ST500DM002	500GB S3	Barracuda
	ST31000333AS	1TB	7200 11
	ST31000340AS	1TB	7200 11
	ST31000340NS	1TB	Barracuda ES.2
	ST31000340SV	1TB	SV35.3
	ST31000322CS	1TB	Pipeline HD .2
	ST31000525SV	1TB	SV35.5
	ST31000526SV	1TB	SV35.5
	ST31000524AS	1TB S3	7200 12
	ST1000DM003	1TB S3	Barracuda
	ST1000VX000	1TB S3	SV35
	ST1500DL003	1.5TB S3	Barracuda LP
	ST31500341AS	1.5TB	7200 11
	ST2000DL003	2TB S3	Barracuda LP
	ST33000651AS	3TB S3	Barracuda XP
WD	WD1600AAJS	160GB	7200 CB
	WD2500AAKS	250GB	7200 CB
	WD2500AVVS	250GB	7200 GP
	WD3200AVVS-73L2B0	320GB	7200 GP
	WD5000AACS	500GB	7200 GP
	WD5000AVVS	500GB	7200 GP
	WD5000AAKS	500GB	7200 CB
	WD5002ABYS	500GB	7200 RE
	WD5000AVDS	500GB	AV-GP
	WS5003ABYX	500GB	Enterprise Storage
	WD5000AAKX	500GB S3	Caviar Blue
	WD5000AUDX	500GB S3	AV-GP

WD	WD5003AZEX	500GB S3	Caviar Black
	WD6400AAKS	640GB	7200 BLUE
	WD6400AVVS	640GB	7200 GP
	WD7500AACS	750GB	7200 GP
	WD7500AVVS	750GB	7200 GP
	WD1003FBYX	1TB	Enterprise Storage
	WD1002FAEX	1TB S3	Caviar Black
	WD10EACS	1TB	7200 GP
	WD10EADS	1TB	Caviar Green
	WD10EVDS	1TB	Green Power
	WD10EVVS	1TB	7200 GP
	WD10EARS	1TB	Caviar Green
	WD10EURX	1TB S3	AV-GP
	WD10EALX	1TB S3	Caviar Blue
	WD10EFRX	1TB	
	WD15EADS	1.5TB	7200 GP
	WD15EARS	1.5TB	7200 GP
	WD15EURS	1.5TB	7200 GP
	WD5000AVDS-63U7B0	1.5TB	7200 GP
	WD15EVDS	1.5TB	7200 GP
	WD20EADS	2.0TB	7200 GP
	WD20EVDS-63T3B0	2.0TB	7200 GP
	WD20EARS	2.0TB	Caviar Green
	WD20EURS	2.0TB	7200 GP
	WD20EZR	2.0TB	Caviar Green
	WD30EURS	3TB	CE-GP
HITACHI	HDS721616PLA380	160GB	7200
	HDT725025VLA380	250GB	7200
	HDT725032VLA360	320GB	7200
	HDP725050GLA360	500GB	7200
	HCP725050GLA380	500GB	7200
	HDS721050CLA362	500GB	
	HDT721010SLA360	1TB	7200
	HDS721010CLA332	1TB	7200
	HDS721010CLA362	1TB	

HITACHI	HDS721010DLE630	1TB S3	7200
	HDS722020ALA330	2TB	7200
	HDS723020BLA642	2TB S3	7200
TOSHIBA	DS7SAE202	2TB	
	DT01ACA050	500GB	
	DT01ACA100	1TB	
	DT01ACA200	2TB	
	DT01ABA050V	500GB	
	DT01ABA100V	1TB	
	DT01ABA200V	2TB	

APPENDIX C: ERROR MESSAGE LIST

ERROR MESSAGE	ERROR STATUS & REASON
DISK ACCESS ERROR!	<p>H.D.D. Data structure un-normal.</p> <p>The data is not recorded into the NVR or there bad sectors on NVR H.D.D. Please install another H.D.D. and perform the record again.</p>
UPDATE FILE ERROR!	Please re-download the update file and update again.
FIRMWARE UPGRADE FAILED	Please reboot the NVR and upgrade the firmware. Please send the NVR back to repair when the NVR is not functional.
MEDIA ACCESS FAIL!	<p>The USB file format is incorrect (Please format the pen drive to FAT32) or the Pen Drive is set up to ONLY READ mode when saving the data by using Pen Drive. Please change the ONLY READ mode.</p> <p>The data cannot be burn into the CD/DVD disc. Please change for another CD/DVD disc and backup the file in CD/DVD disc storage.</p>
NO FILE!	<p>There is no upgrade file within the Pen Drive or the name of upgrade file does not correspond with the NVR format.</p> <p>Please adjust the upgrade file name based on the following information.</p> <p>04CH -> UpdateNVR04.bin</p>
USB DEVICE NOT FOUND NO USB	The pen Drive undetected. Please Unplug the Pen Drive and plug it again.
BACKUP START TIME ERROR	Backup start time error.
BACKUPEND TIME ERROR	Backup end time error.
DISK ERROR	The data cannot be burn into the CD/DVD disc. Please change for another CD/DVD disc and backup the file.
FAN FAILED	Fan Error Warning.
NO LOG DATA	No Events Record.
SCHEDULE RECORD	<p>The condition is caused by trying to stop recording when performing the schedule record.</p> <p>Please setup the record to manual mode and then stop the recording.</p>

PLEASE SELECT ONE
CAMERA

The message will be shown while using the ZOOM function under split screen mode. Please switch the screen into full screen mode and then operate the ZOOM function.

V1.1_131022